

ARMOBANY



LEGO
VANITY
HABITAT
SLIDER
ALTERNE
HOLE
SPIRIT
INFINITY
PETIT



Meubles de la
salle de bain



LEGO

04



VANITY

12



HABITAT

20



SLIDER

36



ALTERNE

46



HOLE

56



SPIRIT

64



INFINITY

74

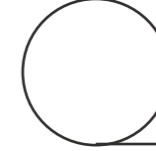

PETIT

84

LEGO



LEGO fresne glaciale
Set 80cm: 653.00€
Colonne: 250.00€



LEGO ciment
Set 100cm: **769.00€**
Colonne: 250.00€



LEGO chêne clair
Set 80cm: **609.00€**
Armoire: 140.00€



LEGO pine Jackson
Set 80cm: **609.00€**

LEGO

MEUBLE LAVABO AVEC 3 TIROIRS ET 1 PORTE

| | H*L*P | Code | Finitions | PPHT |
|--|--------------------|-----------|----------------|----------|
| | 826 x 796 x 455 mm | MB528030F | FRESNE GLACIAL | 379.00 € |
| | | MB528031F | CHÊNE CLAIR | 379.00 € |
| | | MB528032F | CIMENT | 379.00 € |
| | | MB528035F | PINE JACKSON | 379.00 € |
| | 826 x 996 x 455 mm | MB521030F | FRESNE GLACIAL | 418.00 € |
| | | MB521031F | CHÊNE CLAIR | 418.00 € |
| | | MB521032F | CIMENT | 418.00 € |
| | | MB521035F | PINE JACKSON | 418.00 € |

ARMOIRE AVEC 2 PORTES RÉVERSIBLES

| | H*L*P | Code | Finitions | PPHT |
|--|--------------------|----------|----------------|----------|
| | 704 x 300 x 180 mm | A523030F | FRESNE GLACIAL | 140.00 € |
| | | A523031F | CHÊNE CLAIR | 140.00 € |
| | | A523032F | CIMENT | 140.00 € |
| | | A523035F | PINE JACKSON | 140.00 € |

COLONNE AVEC 2 PORTES RÉVERSIBLES

| | H*L*P | Code | Finitions | PPHT |
|--|---------------------|----------|----------------|----------|
| | 1620 x 300 x 290 mm | T523030F | FRESNE GLACIAL | 250.00 € |
| | | T523031F | CHÊNE CLAIR | 250.00 € |
| | | T523032F | CIMENT | 250.00 € |
| | | T523035F | PINE JACKSON | 250.00 € |

LAVABO CÉRAMIQUE RADO

| | H*L*P | Code | Finitions | PPHT |
|--|-----------------|-----------|----------------|----------|
| | 19 x 810 x 460 | LA108018F | BLANC BRILLANT | 112.00 € |
| | 19 x 1010 x 460 | LA101018F | | 156.00 € |

FINITIONS



FRESNE GLACIAL



CIMENT



CHÊNE CLAIR



PINE JACKSON

MIROIR LISSE

| | H*L*P | Code | Finitions | PPHT |
|--|--------------------|-----------|-----------|---------|
| | 704 x 800 x 20 mm | ES408040F | ALUMINIUM | 73.00 € |
| | 704 x 1000 x 20 mm | ES401040F | | 94.00 € |

ÉCLAIRAGE LED









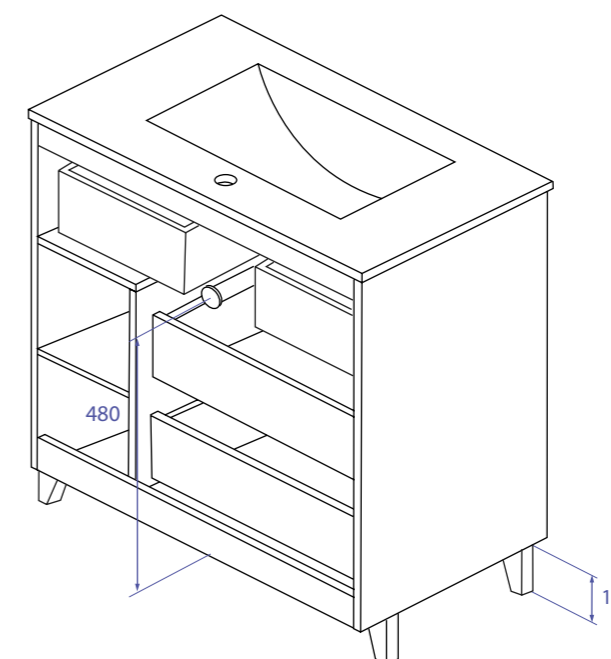

| | H*L*P | Code | Finitions | PPHT |
|--|-------------------|-----------|-----------|---------|
| | 50 x 300 x 100 mm | IL103010F | CHROME | 45.00 € |
| | 50 x 600 x 100 mm | IL106010F | | 86.00 € |

MIROIR LED LINEAL

| | H*L*P | Code | Finitions | PPHT |
|--|--------------------|-----------|-----------|----------|
| | 704 x 800 x 30 mm | ES418040F | ALUMINIUM | 162.00 € |
| | 704 x 1000 x 30 mm | ES411040F | | 195.00 € |

| | |
|------------------|--|
| STRUCTURE | Panneaux de 18mm |
| FAÇADE | Panneaux de 18mm mélamine imitation bois ou ciment |
| LATERAUX | Panneaux de 18mm mélamine imitation bois ou ciment |
| POIGNEES / PIEDS | Sans poignées. ABS pieds avec finition chrome mat |
| TIROIRS | Avec guide en polilaminé gris et fermeture avec amortisseur incorporé |
| CHARNIERES | Ouverture 105°, tête charnière 35mm, montage rapide, fermeture avec amortisseur hydraulique incorporé |
| FIXATION MURALE | Fixations invisibles, montage directe de grande résistance à la charge, réglage en Prof. et hauteur |
| TABLETTES | Tablettes de 18 mm en mélaminé assorties au fini extérieur |
| FINITIONS |  FRESNE GLACIAL  CIMENT  CHÊNE CLAIR  PINE JACKSON |



-  Standard EN 120
-  Lumière LED
-  Plan Vasque Céramique
-  Système Soft Close Tirroirs
-  Conformité Européenne
-  IP 44 - Class II
-  Mélamine
-  Système Soft Close Portes
-  Garantie de 2 ans
-  Miroir avec lumière intégrée

VANITY



VANITY blanc brillant
Set 120cm avec 4 Tiroirs: **914.00€**
Armoire Etage: 120.00€



VANITY chêne clair
 Set 100cm: **556.00€**
 Armoire: 140.00€





VANITY fresne gris
 Set 80cm: **584.00€**
 Colonne: 250.00€



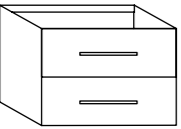
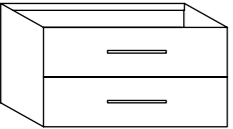

VANITY fresne thé
 Set 60cm: **377.00€**

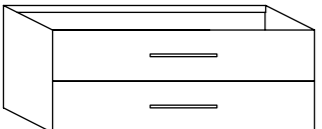
MEUBLE LAVABO AVEC 2 TIROIRS

| | H*L*P | Code | Finitions | PPHT |
|---|----------------------------------|------------|---------------------|----------|
|  | 540 x 596 x 455 mm | 103016012F | FRESNE THÉ | 187.00 € |
| | | 103016013F | FRESNE GRIS | 187.00 € |
| | | 103016031F | CHÊNE CLAIR | 187.00 € |
| | | 103016018F | BLANC BRILLANT | 208.00 € |
| | | 103016020F | ANTHRACITE BRILLANT | 208.00 € |
|  | 540 x 796 x 455 mm | 103018012F | FRESNE THÉ | 208.00 € |
| | | 103018013F | FRESNE GRIS | 208.00 € |
| | | 103018031F | CHÊNE CLAIR | 208.00 € |
| | | 103018018F | BLANC BRILLANT | 228.00 € |
| | | 103018020F | ANTHRACITE BRILLANT | 228.00 € |
|  | 540 x 996 x 455 mm | 103011012F | FRESNE THÉ | 220.00 € |
| | | 103011013F | FRESNE GRIS | 220.00 € |
| | | 103011031F | CHÊNE CLAIR | 220.00 € |
| | | 103011018F | BLANC BRILLANT | 277.00 € |
| | | 103011020F | ANTHRACITE BRILLANT | 277.00 € |
|  | 540 x 1196 x 455 mm 2 Vasques | 103013012F | FRESNE THÉ | 375.00 € |
| | | 103013013F | FRESNE GRIS | 375.00 € |
| | | 103013031F | CHÊNE CLAIR | 375.00 € |
| | | 103013018F | BLANC BRILLANT | 415.00 € |
| | | 103013020F | ANTHRACITE BRILLANT | 415.00 € |

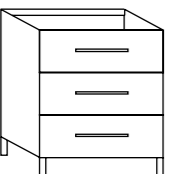
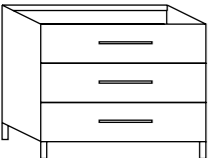
MEUBLE LAVABO AVEC 3 TIROIRS ET PIEDS

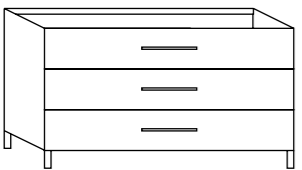
| | H*L*P | Code | Finitions | PPHT |
|---|----------------------------------|------------|---------------------|----------|
|  | 826 x 596 x 455 mm | 103026012F | FRESNE THÉ | 277.00 € |
| | | 103026013F | FRESNE GRIS | 277.00 € |
| | | 103026031F | CHÊNE CLAIR | 277.00 € |
| | | 103026018F | BLANC BRILLANT | 330.00 € |
| | | 103026020F | ANTHRACITE BRILLANT | 330.00 € |
|  | 826 x 796 x 455 mm | 103028012F | FRESNE THÉ | 310.00 € |
| | | 103028013F | FRESNE GRIS | 310.00 € |
| | | 103028031F | CHÊNE CLAIR | 310.00 € |
| | | 103028018F | BLANC BRILLANT | 360.00 € |
| | | 103028020F | ANTHRACITE BRILLANT | 360.00 € |
|  | 826 x 996 x 455 mm | 103021012F | FRESNE THÉ | 348.00 € |
| | | 103021013F | FRESNE GRIS | 348.00 € |
| | | 103021031F | CHÊNE CLAIR | 348.00 € |
| | | 103021018F | BLANC BRILLANT | 415.00 € |
| | | 103021020F | ANTHRACITE BRILLANT | 415.00 € |
|  | 826 x 1196 x 455 mm 2 Vasques | 103021312F | FRESNE THÉ | 550.00 € |
| | | 103021313F | FRESNE GRIS | 550.00 € |
| | | 103021331F | CHÊNE CLAIR | 550.00 € |
| | | 103021318F | BLANC BRILLANT | 590.00 € |
| | | 103021320F | ANTHRACITE BRILLANT | 590.00 € |

ARMOIRE AVEC 1 PORTE RÉVERSIBLE

| | H*L*P | Code | Finitions | PPHT |
|---|--------------------|------------|---------------------|----------|
|  | 704 x 300 x 180 mm | 103233012F | FRESNE THÉ | 140.00 € |
| | | 103233013F | FRESNE GRIS | 140.00 € |
| | | 103233031F | CHÊNE CLAIR | 140.00 € |
| | | 103233018F | BLANC BRILLANT | 165.00 € |
| | | 103233020F | ANTHRACITE BRILLANT | 165.00 € |

ARMOIRE ÉTAGE

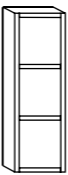
| | H*L*P | Code | Finitions | PPHT |
|---|--------------------|------------|---------------------|----------|
|  | 704 x 200 x 120 mm | 104052012F | FRESNE THÉ | 112.00 € |
| | | 104052013F | FRESNE GRIS | 112.00 € |
| | | 104052031F | CHÊNE CLAIR | 112.00 € |
| | | 104052018F | BLANC BRILLANT | 120.00 € |
| | | 104052020F | ANTHRACITE BRILLANT | 120.00 € |

COLONNE AVEC 2 PORTES RÉVERSIBLES

| | H*L*P | Code | Finitions | PPHT |
|--|---------------------|------------|---------------------|----------|
|  | 1620 x 300 x 290 mm | 103043012F | FRESNE THÉ | 250.00 € |
| | | 103043013F | FRESNE GRIS | 250.00 € |
| | | 103043031F | CHÊNE CLAIR | 250.00 € |
| | | 103043018F | BLANC BRILLANT | 287.00 € |
| | | 103043020F | ANTHRACITE BRILLANT | 287.00 € |

LAVABO CÉRAMIQUE RADO

| | H*L*P | Code | Finitions | PPHT |
|---|------------------------------|-------------|----------------|----------|
|  | 19 x 610 x 460 | LA106018F | BLANC BRILLANT | 87.00 € |
| | 19 x 810 x 460 | LA108018F | | 112.00 € |
| | 19 x 1010 x 460 | LA101018F | | 156.00 € |
| | 19 x 1210 x 460 2 Vasques | LA1012182SF | | 304.00 € |



MIROIR LISSE





| H*L*P | Code | Finitions | PPHT |
|---------------------------|-----------|-----------|----------|
| 704 x 600 x 20 mm | ES406040F | ALUMINIUM | 58.00 € |
| 704 x 800 x 20 mm | ES408040F | | 73.00 € |
| 704 x 1000 x 20 mm | ES401040F | | 94.00 € |
| 704 x 1200 x 20 mm | ES401240F | | 107.00 € |

ÉCLAIRAGE LED









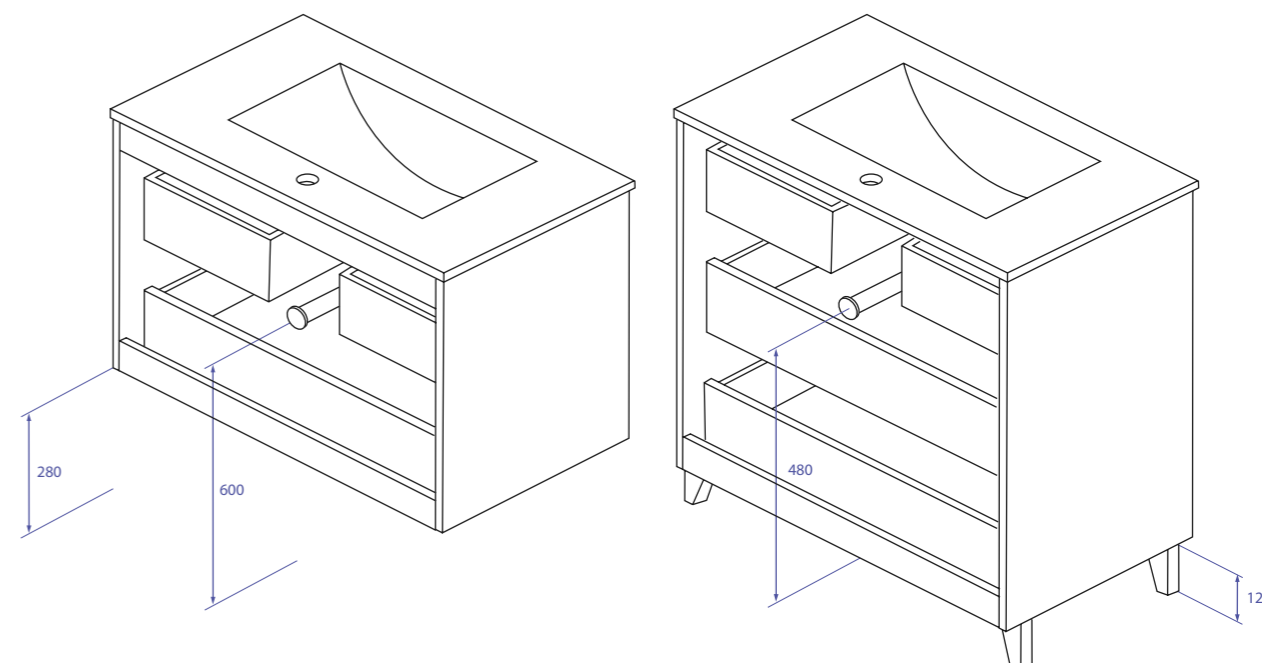

| H*L*P | Code | Finitions | PPHT |
|--------------------------|-----------|-----------|---------|
| 50 x 300 x 100 mm | IL103010F | CHROME | 45.00 € |
| 50 x 600 x 100 mm | IL106010F | | 86.00 € |

MIROIR LED LINEAL

| H*L*P | Code | Finitions | PPHT |
|---------------------------|-----------|-----------|----------|
| 704 x 600 x 30 mm | ES416040F | ALUMINIUM | 128.00 € |
| 704 x 800 x 30 mm | ES418040F | | 162.00 € |
| 704 x 1000 x 30 mm | ES411040F | | 195.00 € |
| 704 x 1200 x 30 mm | ES411240F | | 214.00 € |

| | |
|-------------------------|--|
| STRUCTURE | Panneaux de 18mm |
| FAÇADE | Panneaux de 18mm: Structurés en mélaminé et finition brillant couleurs en MDF laqué |
| LATERAUX | Panneaux de 18mm: Structurés en mélaminé et finition brillant couleurs en MDF laqué |
| POIGNEES / PIEDS | Métalliques poignées avec finition chromée brillant. ABS pieds avec finition chrome mat |
| TIROIRS | Avec guide en polilaminé gris et fermeture avec amortisseur incorporé |
| CHARNIERES | Ouverture 105°, tête charnière 35mm, montage rapide, fermeture avec amortisseur hydraulique incorporé |
| FIXATION MURALE | Fixations invisibles, montage direct de grande résistance à la charge, réglage en Prof. et hauteur |
| TABLETTES | Tablettes de 18 mm en mélaminé assorties au fini extérieur |
| FINITIONS |  FRESNE THÉ  FRESNE GRIS  CHÊNE CLAIR  BLANC BRILLANT  ANTHRACITE BRILLANT |



-  Standard EN 120
-  Lumière LED
-  Plan Vasque Céramique
-  Système Soft Close Tirors
-  Conformité Européenne
-  IP 44 - Class II
-  Mélamine
-  Système Soft Close Portes
-  Garantie de 2 ans
-  Miroir avec lumière intégrée
-  Laqué Haute Brillance

HABITAT

| ensembles



HABITAT anthracite brillant
Set 100cm: **750.00€**
Armoire: 169.00€



HABITAT fresne thé
Set 120cm avec 4 Tiroirs: **1110.00€**
Colonne: 250.00€



HABITAT chêne clair
Set 120cm: **842.00€**



HABITAT fresne gris
Set 60cm: **486.00€**
Colonne: 250.00€



HABITAT blanc brillant
Set 80cm: **595.00€**
Armoire: 169.00€

HABITAT

| modulaire



HABITAT anthracite brillant
Set 200cm: **1798.00€**
Armoire (x2): 338.00€



HABITAT fresne gris
Set 120cm: **965.00€**



HABITAT blanc brillant
Set 180cm: **1648.00€**
Armoire (x2): 338.00€



HABITAT chêne clair
Set 100cm: **851.00€**

MEUBLE LAVABO AVEC 2 TIROIRS

| | H*L*P | Code | Finitions | PPHT |
|--|---------------------------------|------------|---------------------|----------|
| | 540 x 596 x 455 mm | 102016012F | FRESNE THÉ | 296.00 € |
| | | 102016013F | FRESNE GRIS | 296.00 € |
| | | 102016031F | CHÊNE CLAIR | 296.00 € |
| | | 102016018F | BLANC BRILLANT | 324.00 € |
| | | 102016020F | ANTHRACITE BRILLANT | 324.00 € |
| | 540 x 696 x 455 mm | 102017012F | FRESNE THÉ | 316.00 € |
| | | 102017013F | FRESNE GRIS | 316.00 € |
| | | 102017031F | CHÊNE CLAIR | 316.00 € |
| | | 102017018F | BLANC BRILLANT | 348.00 € |
| | | 102017020F | ANTHRACITE BRILLANT | 348.00 € |
| | 540 x 796 x 455 mm | 102018012F | FRESNE THÉ | 328.00 € |
| | | 102018013F | FRESNE GRIS | 328.00 € |
| | | 102018031F | CHÊNE CLAIR | 328.00 € |
| | | 102018018F | BLANC BRILLANT | 360.00 € |
| | | 102018020F | ANTHRACITE BRILLANT | 360.00 € |
| | 540 x 996 x 455 mm | 102011012F | FRESNE THÉ | 344.00 € |
| | | 102011013F | FRESNE GRIS | 344.00 € |
| | | 102011031F | CHÊNE CLAIR | 344.00 € |
| | | 102011018F | BLANC BRILLANT | 399.00 € |
| | | 102011020F | ANTHRACITE BRILLANT | 399.00 € |
| | 540 x 1196 x 455 mm 1 Vasque | 102011212F | FRESNE THÉ | 374.00 € |
| | | 102011213F | FRESNE GRIS | 374.00 € |
| | | 102011231F | CHÊNE CLAIR | 374.00 € |
| | | 102011218F | BLANC BRILLANT | 430.00 € |
| | | 102011220F | ANTHRACITE BRILLANT | 430.00 € |

MEUBLE LAVABO AVEC 2 PORTES

| | H*L*P | Code | Finitions | PPHT |
|--|--------------------|------------|---------------------|----------|
| | 540 x 596 x 455 mm | 100126012F | FRESNE THÉ | 168.00 € |
| | | 100126013F | FRESNE GRIS | 168.00 € |
| | | 100126031F | CHÊNE CLAIR | 168.00 € |
| | | 100126018F | BLANC BRILLANT | 192.00 € |
| | | 100126020F | ANTHRACITE BRILLANT | 192.00 € |
| | 540 x 696 x 455 mm | 100127012F | FRESNE THÉ | 172.00 € |
| | | 100127013F | FRESNE GRIS | 172.00 € |
| | | 100127031F | CHÊNE CLAIR | 172.00 € |
| | | 100127018F | BLANC BRILLANT | 200.00 € |
| | | 100127020F | ANTHRACITE BRILLANT | 200.00 € |
| | 540 x 796 x 455 mm | 100128012F | FRESNE THÉ | 176.00 € |
| | | 100128013F | FRESNE GRIS | 176.00 € |
| | | 100128031F | CHÊNE CLAIR | 176.00 € |
| | | 100128018F | BLANC BRILLANT | 210.00 € |
| | | 100128020F | ANTHRACITE BRILLANT | 210.00 € |

MEUBLE LAVABO AVEC 2 TIROIRS ET 1 PORTE

| | H*L*P | Code | Finitions | PPHT |
|--|--------------------|------------|---------------------|----------|
| | 540 x 796 x 455 mm | 102138012F | FRESNE THÉ | 390.00 € |
| | | 102138013F | FRESNE GRIS | 390.00 € |
| | | 102138031F | CHÊNE CLAIR | 390.00 € |
| | | 102138018F | BLANC BRILLANT | 448.00 € |
| | | 102138020F | ANTHRACITE BRILLANT | 448.00 € |
| | 540 x 796 x 455 mm | 102148012F | FRESNE THÉ | 390.00 € |
| | | 102148013F | FRESNE GRIS | 390.00 € |
| | | 102148031F | CHÊNE CLAIR | 390.00 € |
| | | 102148018F | BLANC BRILLANT | 448.00 € |
| | | 102148020F | ANTHRACITE BRILLANT | 448.00 € |

MEUBLE LAVABO AVEC 2 TIROIRS ET ÉTAGÈRES

| | H*L*P | Code | Finitions | PPHT |
|--|--------------------|------------|---------------------|----------|
| | 540 x 796 x 455 mm | 102158012F | FRESNE THÉ | 370.00 € |
| | | 102158013F | FRESNE GRIS | 370.00 € |
| | | 102158031F | CHÊNE CLAIR | 370.00 € |
| | | 102158018F | BLANC BRILLANT | 425.00 € |
| | | 102158020F | ANTHRACITE BRILLANT | 425.00 € |
| | 540 x 796 x 455 mm | 102168012F | FRESNE THÉ | 370.00 € |
| | | 102168013F | FRESNE GRIS | 370.00 € |
| | | 102168031F | CHÊNE CLAIR | 370.00 € |
| | | 102168018F | BLANC BRILLANT | 425.00 € |
| | | 102168020F | ANTHRACITE BRILLANT | 425.00 € |

LAVABO CÉRAMIQUE RADO

| | H*L*P | Code | Finitions | PPHT |
|--|------------------------------|-------------|----------------|----------|
| | 19 x 610 x 460 | LA106018F | BLANC BRILLANT | 87.00 € |
| | 19 x 710 x 460 | LA107018F | | 99.00 € |
| | 19 x 810 x 460 | LA108018F | | 112.00 € |
| | 19 x 1010 x 460 | LA101018F | | 156.00 € |
| | 19 x 1210 x 460 1 Vasque | LA101218F | | 254.00 € |
| | 19 x 1210 x 460 2 Vasques | LA1012182SF | | 304.00 € |



MODULE AVEC 2 TIROIRS

| | H*L*P | Code | Finitions | PPHT |
|--|--------------------|------------|---------------------|----------|
| | 540 x 596 x 455 mm | 102226012F | FRESNE THÉ | 280.00 € |
| | | 102226013F | FRESNE GRIS | 280.00 € |
| | | 102226031F | CHÊNE CLAIR | 280.00 € |
| | | 102226018F | BLANC BRILLANT | 320.00 € |
| | | 102226020F | ANTHRACITE BRILLANT | 320.00 € |
| | 540 x 796 x 455 mm | 102228012F | FRESNE THÉ | 315.00 € |
| | | 102228013F | FRESNE GRIS | 315.00 € |
| | | 102228031F | CHÊNE CLAIR | 315.00 € |
| | | 102228018F | BLANC BRILLANT | 360.00 € |
| | | 102228020F | ANTHRACITE BRILLANT | 360.00 € |

MODULE AVEC 1 PORTE

| | H*L*P | Code | Finitions | PPHT |
|--|--------------------|------------|---------------------|----------|
| | 540 x 200 x 455 mm | 100192012F | FRESNE THÉ | 136.00 € |
| | | 100192013F | FRESNE GRIS | 136.00 € |
| | | 100192031F | CHÊNE CLAIR | 136.00 € |
| | | 100192018F | BLANC BRILLANT | 151.00 € |
| | | 100192020F | ANTHRACITE BRILLANT | 151.00 € |
| | 540 x 200 x 455 mm | 100202012F | FRESNE THÉ | 136.00 € |
| | | 100202013F | FRESNE GRIS | 136.00 € |
| | | 100202031F | CHÊNE CLAIR | 136.00 € |
| | | 100202018F | BLANC BRILLANT | 151.00 € |
| | | 100202020F | ANTHRACITE BRILLANT | 151.00 € |

MODULE ÉTAGE

| | H*L*P | Code | Finitions | PPHT |
|--|--------------------|------------|---------------------|----------|
| | 540 x 200 x 435 mm | 100212012F | FRESNE THÉ | 110.00 € |
| | | 100212013F | FRESNE GRIS | 110.00 € |
| | | 100212031F | CHÊNE CLAIR | 110.00 € |
| | | 100212018F | BLANC BRILLANT | 129.00 € |
| | | 100212020F | ANTHRACITE BRILLANT | 129.00 € |

PLAN TRAVAIL HPL

| | H*L*P | Code | Finitions | PPHT |
|--|--------------------|----------|----------------|----------|
| | 19 x 610 x 460 mm | B386018F | BLANC BRILLANT | 60.00 € |
| | 19 x 710 x 460 mm | B387018F | | 71.00 € |
| | 19 x 810 x 460 mm | B388018F | | 80.00 € |
| | 19 x 910 x 460 mm | B389018F | | 90.00 € |
| | 19 x 1010 x 460 mm | B381018F | | 100.00 € |
| | 19 x 1210 x 460 mm | B381218F | | 119.00 € |
| | 19 x 1410 x 460 mm | B381418F | | 139.00 € |
| | 19 x 1610 x 460 mm | B381618F | | 159.00 € |
| | 19 x 1810 x 460 mm | B381818F | | 178.00 € |
| | 19 x 2010 x 460 mm | B382018F | | 198.00 € |

PLAN TRAVAIL RESINE

| | H*L*P | Code | Finitions | PPHT |
|--|--------------------|-----------|----------------|----------|
| | 16 x 610 x 460 mm | EN106018F | BLANC BRILLANT | 295.00 € |
| | 16 x 710 x 460 mm | EN107018F | | 344.00 € |
| | 16 x 810 x 460 mm | EN108018F | | 393.00 € |
| | 16 x 910 x 460 mm | EN109018F | | 448.00 € |
| | 16 x 1010 x 460 mm | EN101018F | | 497.00 € |
| | 16 x 1210 x 460 mm | EN101218F | | 557.00 € |
| | 16 x 1410 x 460 mm | EN101418F | | 649.00 € |
| | 16 x 1610 x 460 mm | EN101618F | | 742.00 € |
| | 16 x 1810 x 460 mm | EN101818F | | 835.00 € |
| | 16 x 2010 x 460 mm | EN102018F | | 932.00 € |

LAVABO RESINA SUR PLAN

| | H*L*P | Code | Finitions | PPHT |
|--|-------------------|------------|-----------|----------|
| | 45 x 580 x 320 mm | LAV106018F | BLANC MAT | 420.00 € |

LAVABO CÉRAMIQUE RADO

| | H*L*P | Code | Finitions | PPHT |
|---------------------------------|---------------------------------|-------------|----------------|----------|
| | 19 x 610 x 460 mm | LA106018F | BLANC BRILLANT | 87.00 € |
| | 19 x 710 x 460 mm | LA107018F | | 99.00 € |
| | 19 x 810 x 460 mm | LA108018F | | 112.00 € |
| | 19 x 1010 x 460 mm | LA101018F | | 156.00 € |
| | 19 x 1210 x 460 mm 1 Vasque | LA101218F | | 254.00 € |
| | 19 x 1210 x 460 mm 2 Vasques | LA1012182SF | | 304.00 € |
| 19 x 1410 x 460 mm 2 Vasques | LA1014182SF | 754.00 € | | |



COMPOSITIONS AVEC LAVABO CERAMIQUE 100cm

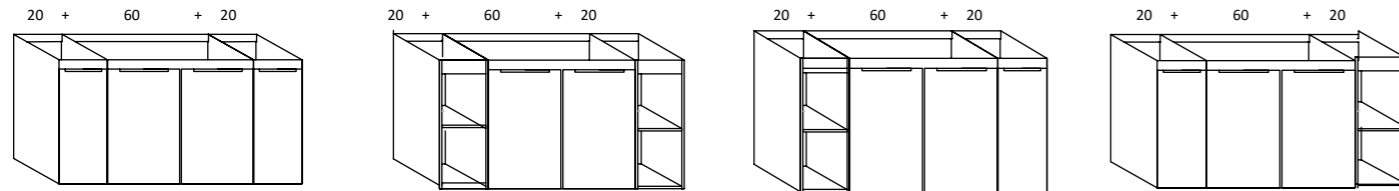
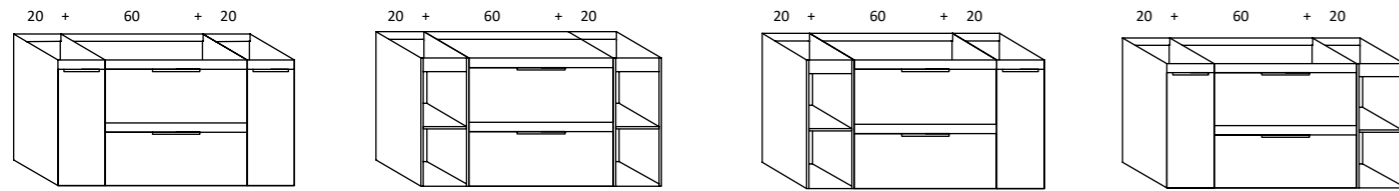

COMPOSITIONS AVEC LAVABO CERAMIQUE 120cm 2 VASQUE

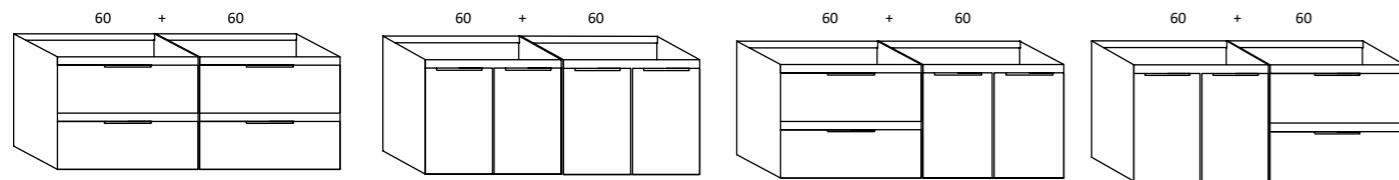

COMPOSITIONS AVEC LAVABO CERAMIQUE 140cm 2 VASQUE

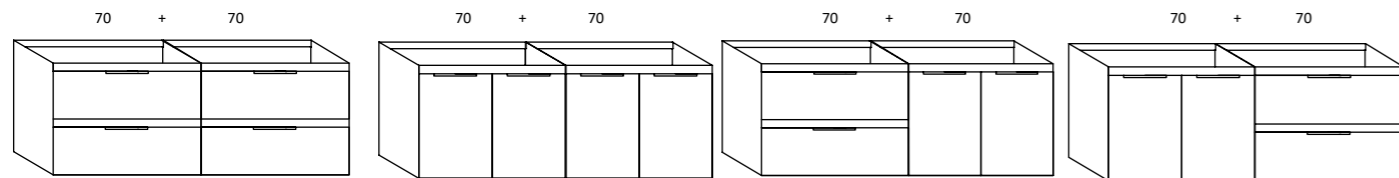

ARMOIRE AVEC 1 PORTE RÉVERSIBLE

| H*L*P | Code | Finitions | PPHT |
|--------------------|------------|---------------------|----------|
| 704 x 300 x 180 mm | 100233012F | FRESNE THÉ | 140.00 € |
| | 100233013F | FRESNE GRIS | 140.00 € |
| | 100233031F | CHÊNE CLAIR | 140.00 € |
| | 100233018F | BLANC BRILLANT | 169.00 € |
| | 100233020F | ANTHRACITE BRILLANT | 169.00 € |

ARMOIRE ÉTAGE

| H*L*P | Code | Finitions | PPHT |
|--------------------|------------|---------------------|----------|
| 704 x 200 x 120 mm | 104052012F | FRESNE THÉ | 112.00 € |
| | 104052013F | FRESNE GRIS | 112.00 € |
| | 104052031F | CHÊNE CLAIR | 112.00 € |
| | 104052018F | BLANC BRILLANT | 120.00 € |
| | 104052020F | ANTHRACITE BRILLANT | 120.00 € |

COLONNE AVEC 2 PORTES RÉVERSIBLES

| H*L*P | Code | Finitions | PPHT |
|---------------------|------------|---------------------|----------|
| 1500 x 300 x 290 mm | 100033012F | FRESNE THÉ | 250.00 € |
| | 100033013F | FRESNE GRIS | 250.00 € |
| | 100033031F | CHÊNE CLAIR | 250.00 € |
| | 100033018F | BLANC BRILLANT | 287.00 € |
| | 100033020F | ANTHRACITE BRILLANT | 287.00 € |



MIROIR LISSE

| H*L*P | Code | Finitions | PPHT |
|--------------------|-----------|-----------|----------|
| 704 x 500 x 20 mm | ES405040F | ALUMINIUM | 52.00 € |
| 704 x 600 x 20 mm | ES406040F | | 58.00 € |
| 704 x 700 x 20 mm | ES407040F | | 65.00 € |
| 704 x 800 x 20 mm | ES408040F | | 73.00 € |
| 704 x 1000 x 20 mm | ES401040F | | 94.00 € |
| 704 x 1200 x 20 mm | ES401240F | | 107.00 € |
| 704 x 1400 x 20 mm | ES401440F | | 145.00 € |

ÉCLAIRAGE LED

| H*L*P | Code | Finitions | PPHT |
|-------------------|-----------|-----------|---------|
| 50 x 300 x 100 mm | IL103010F | CHROME | 45.00 € |
| 50 x 600 x 100 mm | IL106010F | | 86.00 € |

MIROIR LED LINEAL

| H*L*P | Code | Finitions | PPHT |
|--------------------|-----------|-----------|----------|
| 704 x 500 x 30 mm | ES415040F | ALUMINIUM | 114.00 € |
| 704 x 600 x 30 mm | ES416040F | | 128.00 € |
| 704 x 700 x 30 mm | ES417040F | | 134.00 € |
| 704 x 800 x 30 mm | ES418040F | | 162.00 € |
| 704 x 1000 x 30 mm | ES411040F | | 195.00 € |
| 704 x 1200 x 30 mm | ES411240F | | 214.00 € |
| 704 x 1400 x 30 mm | ES411440F | | 274.00 € |

STRUCTURE

Panneaux de 18mm

FAÇADE

Panneaux de 18mm: Structurés en mélaminé et finition brillant couleurs en MDF laqué

LATERAUX

Panneaux de 18mm: Structurés en mélaminé et finition brillant couleurs en MDF laqué

POIGNEES / PIEDS

Poignées et pieds en ABS avec finition chromée brillant

TIROIRS

Tiroirs en structure métallique avec glissières occultes, ouverture partielle et fermeture avec amortisseur incorporé

CHARNIERES

Ouverture 105°, tête charnière 35mm, montage rapide, fermeture avec amortisseur hydraulique incorporé

FIXATION MURALE

Fixations invisibles, montage directe de grande résistance à la charge, réglage en Prof. et hauteur

TABLETTES

Tablettes de 18 mm en mélaminé assorties au fini extérieur

FINITIONS



FRESNE THÉ



FRESNE GRIS



CHÊNE CLAIR



BLANC BRILLANT



ANTHRACITE BRILLANT

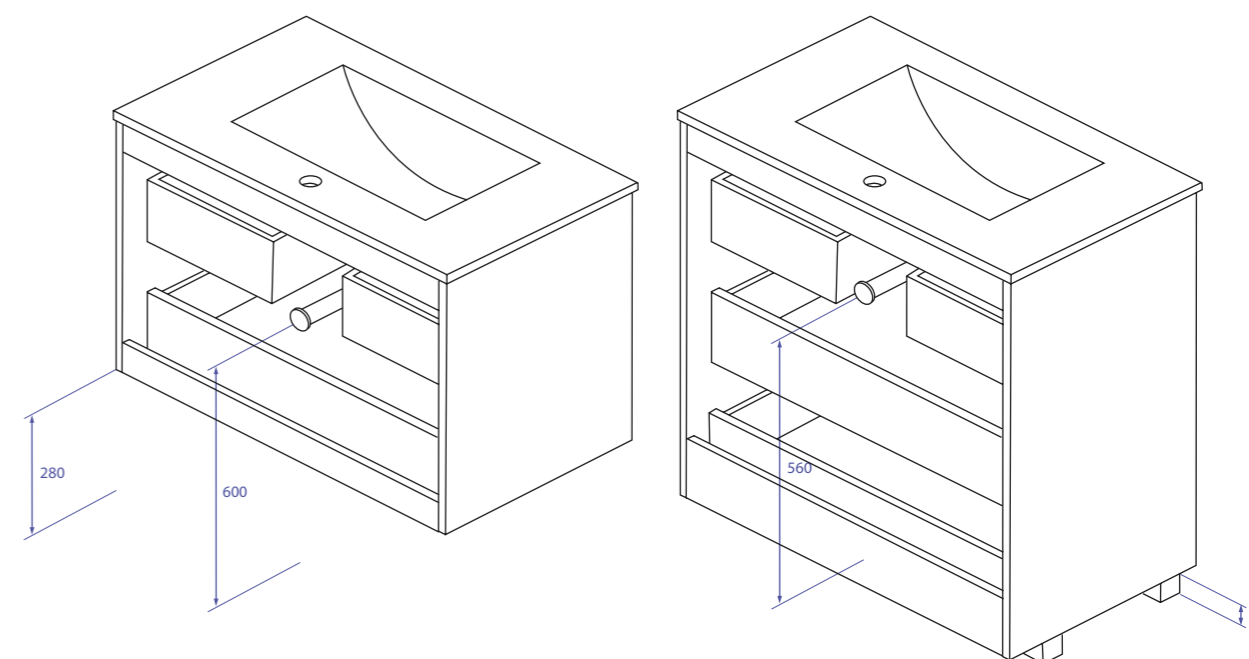

E-1 Standard EN 120

LED Lumière LED

Plan Vasque Céramique

SOFT CLOSE Système Soft Close Tiroirs

CE Conformité Européenne

IP44 CLASS II IP 44 - Class II

Mélamine

SOFT CLOSE Système Soft Close Portes

VDE SANITAIRE Garantie de 2 ans

Miroir avec lumière intégrée

Laqué Haute Brillance

SLIDER



SLIDER chêne clair
Set 100cm: **754.00€**
Colonne: 260.00€



SLIDER blanc brillant
Set 100cm: **949.00€**



SLIDER anthracite
Set 120cm: **1008.00€**



SLIDER fresne thé
Set 60cm: **524.00€**



SLIDER fresne gris
Set 80cm: **642.00€**

MEUBLE LAVABO AVEC 2 TIROIRS

| | H*L*P | Code | Finitions | PPHT |
|--|----------------------------------|------------|---------------------|----------|
| | 540 x 596 x 455 mm | 106016012F | FRESNE THÉ | 334.00 € |
| | | 106016013F | FRESNE GRIS | 334.00 € |
| | | 106016031F | CHÊNE CLAIR | 334.00 € |
| | | 106016018F | BLANC BRILLANT | 368.00 € |
| | | 106016020F | ANTHRACITE BRILLANT | 368.00 € |
| | 540 x 796 x 455 mm | 106018012F | FRESNE THÉ | 368.00 € |
| | | 106018013F | FRESNE GRIS | 368.00 € |
| | | 106018031F | CHÊNE CLAIR | 368.00 € |
| | | 106018018F | BLANC BRILLANT | 417.00 € |
| | | 106018020F | ANTHRACITE BRILLANT | 417.00 € |
| | 540 x 996 x 455 mm | 106011012F | FRESNE THÉ | 403.00 € |
| | | 106011013F | FRESNE GRIS | 403.00 € |
| | | 106011031F | CHÊNE CLAIR | 403.00 € |
| | | 106011018F | BLANC BRILLANT | 452.00 € |
| | | 106011020F | ANTHRACITE BRILLANT | 452.00 € |
| | 540 x 1196 x 455 mm 2 Vasques | 100261212F | FRESNE THÉ | 445.00 € |
| | | 100261213F | FRESNE GRIS | 445.00 € |
| | | 100261231F | CHÊNE CLAIR | 445.00 € |
| | | 100261218F | BLANC BRILLANT | 507.00 € |
| | | 100261220F | ANTHRACITE BRILLANT | 507.00 € |

ARMOIRE AVEC 1 PORTE

| | H*L*P | Code | Finitions | PPHT |
|--|--------------------|------------|---------------------|----------|
| | 704 x 350 x 160 mm | 106233512F | FRESNE THÉ | 145.00 € |
| | | 106233513F | FRESNE GRIS | 145.00 € |
| | | 106233531F | CHÊNE CLAIR | 145.00 € |
| | | 106233518F | BLANC BRILLANT | 165.00 € |
| | | 106233520F | ANTHRACITE BRILLANT | 165.00 € |
| | 704 x 350 x 160 mm | 106273512F | FRESNE THÉ | 145.00 € |
| | | 106273513F | FRESNE GRIS | 145.00 € |
| | | 106273531F | CHÊNE CLAIR | 145.00 € |
| | | 106273518F | BLANC BRILLANT | 165.00 € |
| | | 106273520F | ANTHRACITE BRILLANT | 165.00 € |

COLONNE AVEC 2 PORTES RÉVERSIBLES

| | H*L*P | Code | Finitions | PPHT |
|--|---------------------|------------|---------------------|----------|
| | 1500 x 350 x 272 mm | 106033512F | FRESNE THÉ | 260.00 € |
| | | 106033513F | FRESNE GRIS | 260.00 € |
| | | 106033531F | CHÊNE CLAIR | 260.00 € |
| | | 106033518F | BLANC BRILLANT | 295.00 € |
| | | 106033520F | ANTHRACITE BRILLANT | 295.00 € |

LAVABO CÉRAMIQUE RADO

| | H*L*P | Code | Finitions | PPHT |
|--|------------------------------|-------------|----------------|----------|
| | 19 x 610 x 460 | LA106018F | BLANC BRILLANT | 87.00 € |
| | 19 x 810 x 460 | LA108018F | | 112.00 € |
| | 19 x 1010 x 460 | LA101018F | | 254.00 € |
| | 19 x 1210 x 460 2 Vasques | LA1012182SF | | 304.00 € |

LAVABO RESINE CORAL

| | H*L*P | Code | Finitions | PPHT |
|--|------------------------------|-----------|----------------|----------|
| | 50 x 810 x 460 | LA118018F | BLANC BRILLANT | 237.00 € |
| | 50 x 1010 x 460 | LA111018F | | 302.00 € |
| | 50 x 1210 x 460 2 Vasques | LA111218F | | 351.00 € |

MIROIR LISSE

| | H*L*P | Code | Finitions | PPHT |
|--|--------------------|-----------|-----------|----------|
| | 704 x 600 x 20 mm | ES406040F | ALUMINIUM | 58.00 € |
| | 704 x 800 x 20 mm | ES408040F | | 73.00 € |
| | 704 x 1000 x 20 mm | ES401040F | | 94.00 € |
| | 704 x 1200 x 20 mm | ES401240F | | 107.00 € |





ÉCLAIRAGE LED

| | H*L*P | Code | Finitions | PPHT |
|--|-------------------|-----------|-----------|---------|
| | 50 x 300 x 100 mm | IL103010F | CHROME | 45.00 € |
| | 50 x 600 x 100 mm | IL106010F | | 86.00 € |









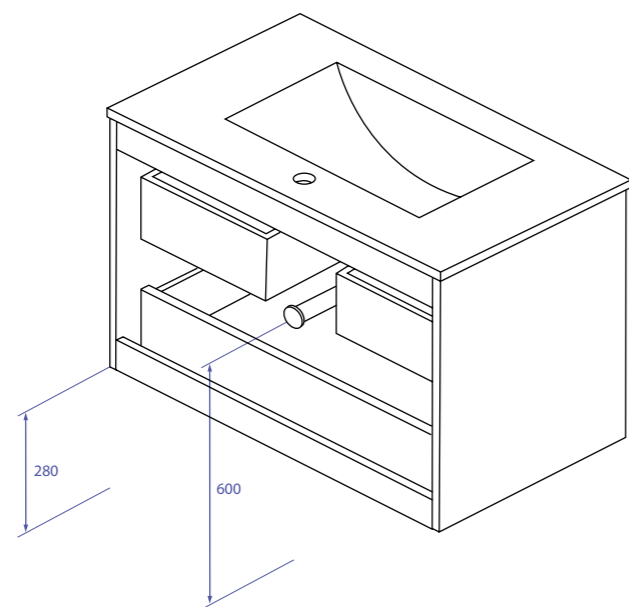

MIROIR LED LINEAL

| | H*L*P | Code | Finitions | PPHT |
|--|--------------------|-----------|-----------|----------|
| | 704 x 600 x 30 mm | ES416040F | ALUMINIUM | 128.00 € |
| | 704 x 800 x 30 mm | ES418040F | | 162.00 € |
| | 704 x 1000 x 30 mm | ES411040F | | 195.00 € |
| | 704 x 1200 x 30 mm | ES411240F | | 214.00 € |



| | |
|-----------------|---|
| STRUCTURE | Panneaux de 18mm |
| FAÇADE | Panneaux de 18mm: Structurés en mélaminé et finition brillant couleurs en MDF laqué |
| LATERAUX | Panneaux de 18mm: Structurés en mélaminé et finition brillant couleurs en MDF laqué |
| POIGNEES | Métalliques poignees avec finition aluminium mat |
| TIROIRS | Tiroirs en structure métallique avec glissières occultes, ouverture partielle et fermeture avec amortisseur incorporé |
| CHARNIERES | Ouverture 105°, tête charnière 35mm, montage rapide, fermeture avec amortisseur hydraulique incorporé |
| FIXATION MURALE | Fixations invisibles, montage directe de grande résistance à la charge, réglage en Prof. et hauteur |
| TABLETTES | Tablettes de 18 mm en mélaminé assorties au fini extérieur |
| FINITIONS |  FRESNE THÉ  FRESNE GRIS  CHÊNE CLAIR  BLANC BRILLANT  ANTHRACITE BRILLANT |



- | | | | |
|---|--|---|--|
|  Standard EN 120 |  Lumière LED |  Plan Vasque Céramique |  Système Soft Close Tiroirs |
|  Conformité Européenne |  IP 44 - Class II |  Mélamine |  Système Soft Close Portes |
|  Garantie de 2 ans |  Miroir avec lumière intégrée |  Laqué Haute Brillance | |

ALTERNE



ALTERNE pine Jackson
Set 140cm: **833.00€**
Colonne: 270.00€



ALTERNE anthracite
Set 120cm: **1094.00€**



ALTERNE chêne clair
Set 120cm: **762.00€**

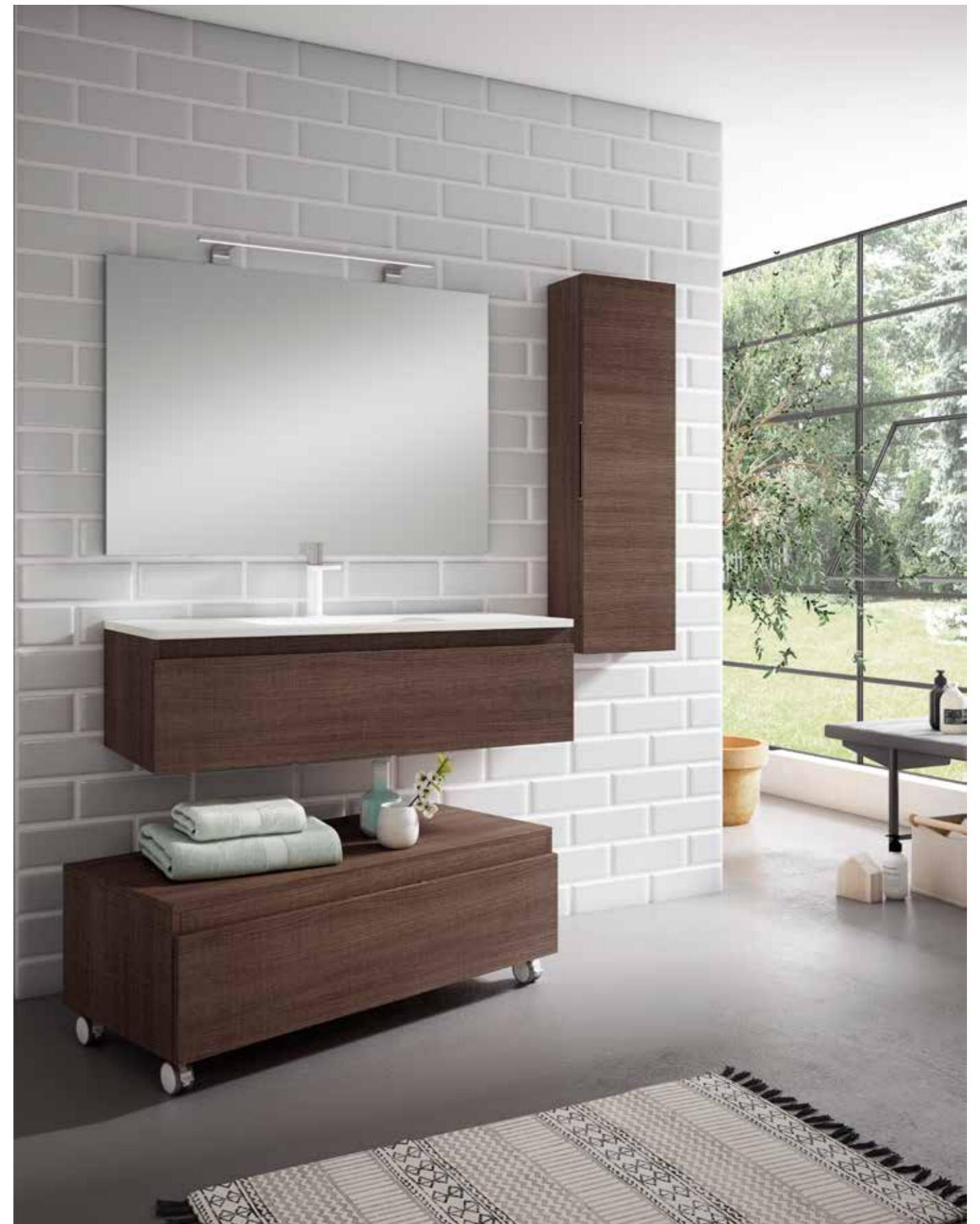

ALTERNE fresne thé
Set 100cm: **592.00€**
Armoire: 180.00€
Meuble avec roues: 299.00€

MODULE LAVABO AVEC 1 TIROIR

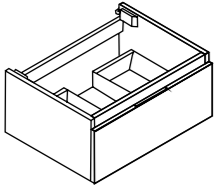
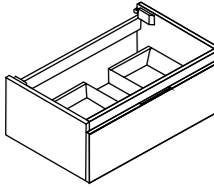
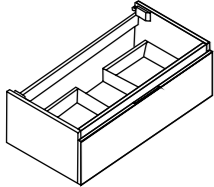
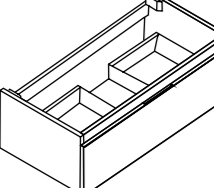
| H*L*P | Code | Finitions | PPHT |
|--|-----------|---------------------|----------|
|  270 x 596 x 455 mm | ML216012F | FRESNE THÉ | 220.00 € |
| | ML216013F | FRESNE GRIS | 220.00 € |
| | ML216031F | CHÊNE CLAIR | 220.00 € |
| | ML216035F | PINE JACKSON | 220.00 € |
| | ML216018F | BLANC BRILLANT | 275.00 € |
| | ML216020F | ANTHRACITE BRILLANT | 275.00 € |
|  270 x 796 x 455 mm | ML218012F | FRESNE THÉ | 240.00 € |
| | ML218013F | FRESNE GRIS | 240.00 € |
| | ML218031F | CHÊNE CLAIR | 240.00 € |
| | ML218035F | PINE JACKSON | 240.00 € |
| | ML218018F | BLANC BRILLANT | 288.00 € |
| | ML218020F | ANTHRACITE BRILLANT | 288.00 € |
|  270 x 996 x 455 mm | ML211012F | FRESNE THÉ | 256.00 € |
| | ML211013F | FRESNE GRIS | 256.00 € |
| | ML211031F | CHÊNE CLAIR | 256.00 € |
| | ML211035F | PINE JACKSON | 256.00 € |
| | ML211018F | BLANC BRILLANT | 290.00 € |
| | ML211020F | ANTHRACITE BRILLANT | 290.00 € |
|  270 x 1196 x 455 mm 1 Vasque | ML211212F | FRESNE THÉ | 315.00 € |
| | ML211213F | FRESNE GRIS | 315.00 € |
| | ML211231F | CHÊNE CLAIR | 315.00 € |
| | ML211235F | PINE JACKSON | 315.00 € |
| | ML211218F | BLANC BRILLANT | 355.00 € |
| | ML211220F | ANTHRACITE BRILLANT | 355.00 € |

MODULE TIROIR AVEC TOP

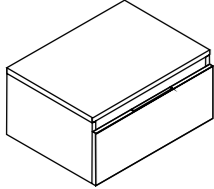
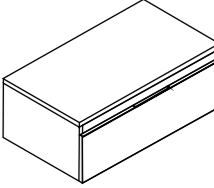
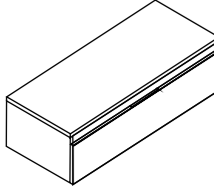
| H*L*P | Code | Finitions | PPHT |
|--|------------|---------------------|----------|
|  290 x 596 x 460 mm | MCT216012F | FRESNE THÉ | 226.00 € |
| | MCT216013F | FRESNE GRIS | 226.00 € |
| | MCT216031F | CHÊNE CLAIR | 226.00 € |
| | MCT216035F | PINE JACKSON | 226.00 € |
| | MCT216018F | BLANC BRILLANT | 302.00 € |
| | MCT216020F | ANTHRACITE BRILLANT | 302.00 € |
|  290 x 796 x 460 mm | MCT218012F | FRESNE THÉ | 249.00 € |
| | MCT218013F | FRESNE GRIS | 249.00 € |
| | MCT218031F | CHÊNE CLAIR | 249.00 € |
| | MCT218035F | PINE JACKSON | 249.00 € |
| | MCT218018F | BLANC BRILLANT | 324.00 € |
| | MCT218020F | ANTHRACITE BRILLANT | 324.00 € |
|  290 x 996 x 460 mm | MCT211012F | FRESNE THÉ | 275.00 € |
| | MCT211013F | FRESNE GRIS | 275.00 € |
| | MCT211031F | CHÊNE CLAIR | 275.00 € |
| | MCT211035F | PINE JACKSON | 275.00 € |
| | MCT211018F | BLANC BRILLANT | 346.00 € |
| | MCT211020F | ANTHRACITE BRILLANT | 346.00 € |

MODULE TIROIR AVEC TOP

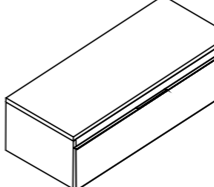
| H*L*P | Code | Finitions | PPHT |
|---|------------|---------------------|----------|
|  290 x 1196 x 460 mm | MCT211212F | FRESNE THÉ | 355.00 € |
| | MCT211213F | FRESNE GRIS | 355.00 € |
| | MCT211231F | CHÊNE CLAIR | 355.00 € |
| | MCT211235F | PINE JACKSON | 355.00 € |
| | MCT211218F | BLANC BRILLANT | 408.00 € |
| | MCT211220F | ANTHRACITE BRILLANT | 408.00 € |

ARMOIRE AVEC 1 PORTE RÉVERSIBLE

| H*L*P | Code | Finitions | PPHT |
|---|----------|---------------------|----------|
|  1000 x 300 x 180 mm | A213012F | FRESNE THÉ | 180.00 € |
| | A213013F | FRESNE GRIS | 180.00 € |
| | A213031F | CHÊNE CLAIR | 180.00 € |
| | A213035F | PINE JACKSON | 180.00 € |
| | A213018F | BLANC BRILLANT | 222.00 € |
| | A213020F | ANTHRACITE BRILLANT | 222.00 € |

COLONNE AVEC 2 PORTES RÉVERSIBLES

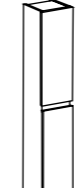
| H*L*P | Code | Finitions | PPHT |
|--|----------|---------------------|----------|
|  1600 x 300 x 300 mm | T213012F | FRESNE THÉ | 270.00 € |
| | T213013F | FRESNE GRIS | 270.00 € |
| | T213031F | CHÊNE CLAIR | 270.00 € |
| | T213035F | PINE JACKSON | 270.00 € |
| | T213018F | BLANC BRILLANT | 310.00 € |
| | T213020F | ANTHRACITE BRILLANT | 310.00 € |

ROUES

| H*L*P | Code | Finitions | PPHT |
|---|----------------------------|-----------|---------|
|  SET 4 ROUES | Diamètre 50 mm R215018F | BLANC | 24.00 € |

LAVABO CÉRAMIQUE RADO

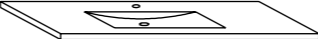
| H*L*P | Code | Finitions | PPHT |
|---|------------------------------|-------------|----------|
|  | 19 x 610 x 460 | LA106018F | 87.00 € |
| | 19 x 810 x 460 | LA108018F | 112.00 € |
| | 19 x 1010 x 460 | LA101018F | 156.00 € |
| | 19 x 1210 x 460 1 Vasque | LA101218F | 254.00 € |
| | 19 x 1210 x 460 2 Vasques | LA1012182SF | 304.00 € |



MIROIR LISSE





| H*L*P | Code | Finitions | PPHT |
|---------------------------|-----------|-----------|----------|
| 704 x 600 x 20 mm | ES406040F | ALUMINIUM | 58.00 € |
| 704 x 700 x 20 mm | ES407040F | | 65.00 € |
| 704 x 800 x 20 mm | ES408040F | | 73.00 € |
| 704 x 1000 x 20 mm | ES401040F | | 94.00 € |
| 704 x 1200 x 20 mm | ES401240F | | 107.00 € |
| 704 x 1400 x 20 mm | ES401440F | | 145.00 € |

ÉCLAIRAGE LED



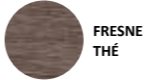

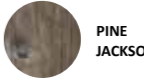



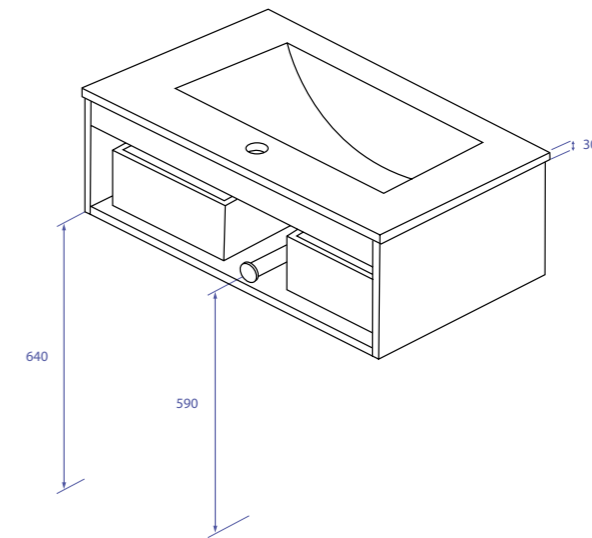

| H*L*P | Code | Finitions | PPHT |
|--------------------------|-----------|-----------|---------|
| 50 x 300 x 100 mm | IL103010F | CHROME | 45.00 € |
| 50 x 600 x 100 mm | IL106010F | | 86.00 € |

MIROIR LED LINEAL

| H*L*P | Code | Finitions | PPHT |
|---------------------------|-----------|-----------|----------|
| 704 x 600 x 30 mm | ES416040F | ALUMINIUM | 128.00 € |
| 704 x 700 x 30 mm | ES417040F | | 134.00 € |
| 704 x 800 x 30 mm | ES418040F | | 162.00 € |
| 704 x 1000 x 30 mm | ES411040F | | 195.00 € |
| 704 x 1200 x 30 mm | ES411240F | | 214.00 € |
| 704 x 1400 x 30 mm | ES411440F | | 274.00 € |

- STRUCTURE** : Panneaux de 18mm
- FAÇADE** : Panneaux de 18mm: Structurés en mélaminé et finition brillant couleurs en MDF laqué
- LATERAUX** : Panneaux de 18mm: Structurés en mélaminé et finition brillant couleurs en MDF laqué
- POIGNEES** : Métalliques poignées avec finition aluminium mat
- TIROIRS** : Tiroirs en structure métallique avec glissières occultes, ouverture partielle et fermeture avec amortisseur incorporé
- CHARNIERES** : Ouverture 105°, tête charnière 35mm, montage rapide, fermeture avec amortisseur hydraulique incorporé
- FIXATION MURALE** : Fixations invisibles, montage direct de grande résistance à la charge, réglage en Prof. et hauteur
- TABLETTES** : Tablettes en verre transparent, 5 mm d'épaisseur avec des bords polis
- FINITIONS** :
 -  FRESNE THÉ
 -  FRESNE GRIS
 -  CHÊNE CLAIR
 -  PINE JACKSON
 -  BLANC BRILLANT
 -  ANTHRACITE BRILLANT



-  Standard EN 120
-  Lumière LED
-  Plan Vasque Céramique
-  Système Soft Close Tiroirs
-  Conformité Européenne
-  IP 44 - Class II
-  Mélamine
-  Système Soft Close Portes
-  Garantie de 2 ans
-  Miroir avec lumière intégrée
-  Laqué Haute Brillance

HOLE



HOLE blanc brillant
Set 100cm: **827.00€**
Colonne: 360.00€

HOLE fresne gris
Set 80cm: **612.00€**
Armoire: 157.00€



HOLE fresne tea
Set 80cm: **656.00€**





HOLE chêne clair
Set 100cm: **764.00€**
Colonne: 306.00€

HOLE

MEUBLE LAVABO AVEC 2 TIROIRS

| | H*L*P | Code | Finitions | PPHT |
|--|--------------------|-------------|---------------------|----------|
| | 540 x 796 x 455 mm | MB2C448012F | FRESNE THÉ | 382.00 € |
| | | MB2C448013F | FRESNE GRIS | 382.00 € |
| | | MB2C448031F | CHÊNE CLAIR | 382.00 € |
| | | MB2C448018F | BLANC BRILLANT | 451.00 € |
| | | MB2C448020F | ANTHRACITE BRILLANT | 451.00 € |
| | 540 x 996 x 455 mm | MB2C441012F | FRESNE THÉ | 413.00 € |
| | | MB2C441013F | FRESNE GRIS | 413.00 € |
| | | MB2C441031F | CHÊNE CLAIR | 413.00 € |
| | | MB2C441018F | BLANC BRILLANT | 491.00 € |
| | | MB2C441020F | ANTHRACITE BRILLANT | 491.00 € |

ARMOIRE AVEC 1 PORTE RÉVERSIBLE

| | H*L*P | Code | Finitions | PPHT |
|------------------|--------------------|-----------|---------------------|----------|
| Porte droite | 920 x 298 x 200 mm | AR443012F | FRESNE THÉ | 157.00 € |
| | | AR443013F | FRESNE GRIS | 157.00 € |
| | | AR443031F | CHÊNE CLAIR | 157.00 € |
| | | AR443018F | BLANC BRILLANT | 182.00 € |
| | | AR443020F | ANTHRACITE BRILLANT | 182.00 € |
| Porte gauche | 920 x 298 x 200 mm | AL443012F | FRESNE THÉ | 157.00 € |
| | | AL443013F | FRESNE GRIS | 157.00 € |
| | | AL443031F | CHÊNE CLAIR | 157.00 € |
| | | AL443018F | BLANC BRILLANT | 182.00 € |
| | | AL443020F | ANTHRACITE BRILLANT | 182.00 € |

COLONNE AVEC 2 PORTES RÉVERSIBLES

| | H*L*P | Code | Finitions | PPHT |
|--|---------------------|----------|---------------------|----------|
| | 1600 x 298 x 200 mm | T443012F | FRESNE THÉ | 306.00 € |
| | | T443013F | FRESNE GRIS | 306.00 € |
| | | T443031F | CHÊNE CLAIR | 306.00 € |
| | | T443018F | BLANC BRILLANT | 360.00 € |
| | | T443020F | ANTHRACITE BRILLANT | 360.00 € |

LAVABO CÉRAMIQUE RADO

| | H*L*P | Code | Finitions | PPHT |
|--|-----------------|-----------|----------------|----------|
| | 19 x 810 x 460 | LA108018F | BLANC BRILLANT | 112.00 € |
| | 19 x 1010 x 460 | LA101018F | | 156.00 € |

FINITIONS



FRESNE THÉ



FRESNE GRIS



CHÊNE CLAIR



BLANC BRILLANT



ANTHRACITE BRILLANT

MIROIR LISSE



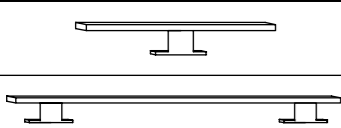

| | H*L*P | Code | Finitions | PPHT |
|---|---------------------------|-----------|-----------|---------|
|  | 704 x 800 x 20 mm | ES408040F | ALUMINIUM | 73.00 € |
| | 704 x 1000 x 20 mm | ES401040F | | 94.00 € |

ÉCLAIRAGE LED









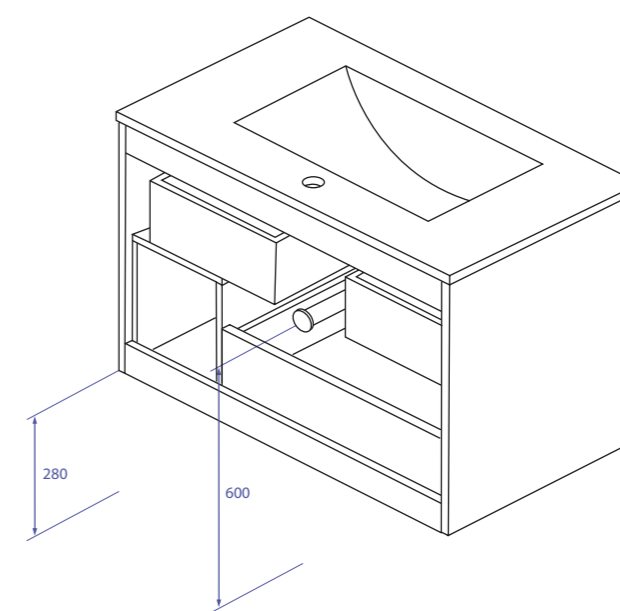

| | H*L*P | Code | Finitions | PPHT |
|---|--------------------------|-----------|-----------|---------|
|  | 50 x 300 x 100 mm | IL103010F | CHROME | 45.00 € |
| | 50 x 600 x 100 mm | IL106010F | | 86.00 € |

MIROIR LED LINEAL

| | H*L*P | Code | Finitions | PPHT |
|---|---------------------------|-----------|-----------|----------|
|  | 704 x 800 x 30 mm | ES418040F | ALUMINIUM | 162.00 € |
| | 704 x 1000 x 30 mm | ES411040F | | 195.00 € |

| | |
|------------------------|--|
| STRUCTURE | Panneaux de 18mm |
| FAÇADE | Panneaux de 18mm: Structurés en mélaminé et finition brillant couleurs en MDF laqué |
| LATERAUX | Panneaux de 18mm: Structurés en mélaminé et finition brillant couleurs en MDF laqué |
| POIGNEES | ABS poignees avec finition chromée brillant |
| TIROIRS | Tiroirs en structure métallique avec glissières occultes, ouverture partielle et fermeture avec amortisseur incorporé |
| CHARNIERES | Ouverture 105°, tête charnière 35mm, montage rapide, fermeture avec amortisseur hydraulique incorporé |
| FIXATION MURALE | Fixations invisibles, montage direct de grande résistance à la charge, réglage en Prof. et hauteur |
| TABLETTES | Tablettes de 18 mm en mélaminé assorties au fini extérieur |
| FINITIONS |  FRESNE THÉ  FRESNE GRIS  CHÊNE CLAIR  BLANC BRILLANT  ANTHRACITE BRILLANT |



-  Standard EN 120
-  Lumière LED
-  Plan Vasque Céramique
-  Système Soft Close Tiroirs
-  Conformité Européenne
-  IP 44 - Class II
-  Mélamine
-  Système Soft Close Portes
-  Garantie de 2 ans
-  Miroir avec lumière intégrée
-  Laqué Haute Brillance

SPIRIT



SPIRIT pine Jackson
Set 100cm: **863.00€**



SPIRIT fresne glacial
Set 80cm: **619.00€**
Armoire: 138.00€



SPIRIT fresne glaciale
Set 60cm: **678.00€**
Colonne: 200.00€



SPIRIT ciment
Set 100cm: **863.00€**



SPiRiT ciment
 Set 100cm: **792.00€**
 Armoire: 138.00€

SPiRiT chêne clair
 Set 80cm: **619.00€**
 Armoire: 138.00€



SPiRiT chêne clair
 Set 100cm: **863.00€**

MEUBLE LAVABO AVEC 2 TIROIRS

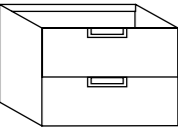
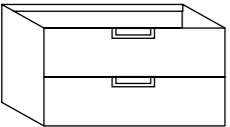
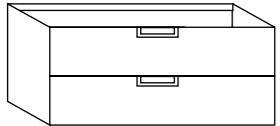
| | H*L*P | Code | Finitions | PPHT |
|---|--------------------|-------------|----------------|----------|
|  | 540 x 596 x 455 mm | MB2C496030F | FRESNE GLACIAL | 363.00 € |
| | | MB2C496031F | CHÈNE CLAIR | 363.00 € |
| | | MB2C496032F | CIMENT | 363.00 € |
| | | MB2C496035F | PINE JACKSON | 363.00 € |
|  | 540 x 796 x 455 mm | MB2C498030F | FRESNE GLACIAL | 389.00 € |
| | | MB2C498031F | CHÈNE CLAIR | 389.00 € |
| | | MB2C498032F | CIMENT | 389.00 € |
| | | MB2C498035F | PINE JACKSON | 389.00 € |
|  | 540 x 996 x 455 mm | MB2C491030F | FRESNE GLACIAL | 441.00 € |
| | | MB2C491031F | CHÈNE CLAIR | 441.00 € |
| | | MB2C491032F | CIMENT | 441.00 € |
| | | MB2C491035F | PINE JACKSON | 441.00 € |

MEUBLE LAVABO AVEC 3 TIROIRS ET PIEDS

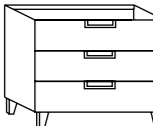
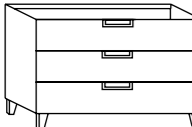
| | H*L*P | Code | Finitions | PPHT |
|---|--------------------|-------------|----------------|----------|
|  | 826 x 596 x 455 mm | MB3C496030F | FRESNE GLACIAL | 463.00 € |
| | | MB3C496031F | CHÈNE CLAIR | 463.00 € |
| | | MB3C496032F | CIMENT | 463.00 € |
| | | MB3C496035F | PINE JACKSON | 463.00 € |
|  | 826 x 796 x 455 mm | MB3C498030F | FRESNE GLACIAL | 488.00 € |
| | | MB3C498031F | CHÈNE CLAIR | 488.00 € |
| | | MB3C498032F | CIMENT | 488.00 € |
| | | MB3C498035F | PINE JACKSON | 488.00 € |
|  | 826 x 996 x 455 mm | MB3C491030F | FRESNE GLACIAL | 527.00 € |
| | | MB3C491031F | CHÈNE CLAIR | 527.00 € |
| | | MB3C491032F | CIMENT | 527.00 € |
| | | MB3C491035F | PINE JACKSON | 527.00 € |

ARMOIRE AVEC 1 PORTE RÉVERSIBLE

| | H*L*P | Code | Finitions | PPHT |
|---|--------------------|----------|----------------|----------|
|  | 704 x 300 x 180 mm | A493030F | FRESNE GLACIAL | 138.00 € |
| | | A493031F | CHÈNE CLAIR | 138.00 € |
| | | A493032F | CIMENT | 138.00 € |
| | | A493035F | PINE JACKSON | 138.00 € |

COLONNE AVEC 2 PORTES RÉVERSIBLES

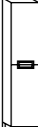
| | H*L*P | Code | Finitions | PPHT |
|---|---------------------|----------|----------------|----------|
|  | 1620 x 300 x 290 mm | T493030F | FRESNE GLACIAL | 200.00 € |
| | | T493031F | CHÈNE CLAIR | 200.00 € |
| | | T493032F | CIMENT | 200.00 € |
| | | T493035F | PINE JACKSON | 200.00 € |

LAVABO CÉRAMIQUE RADO

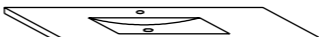
| | H*L*P | Code | Finitions | PPHT |
|---|------------------------------|-------------|----------------|----------|
|  | 19 x 610 x 460 | LA106018F | BLANC BRILLANT | 87.00 € |
| | 19 x 810 x 460 | LA108018F | | 112.00 € |
| | 19 x 1010 x 460 | LA101018F | | 156.00 € |
| | 19 x 1210 x 460 2 Vasques | LA1012182SF | | 304.00 € |

MIROIR LISSÉ

| | H*L*P | Code | Finitions | PPHT |
|---|--------------------|-----------|-----------|----------|
|  | 704 x 600 x 20 mm | ES406040F | ALUMINIUM | 58.00 € |
| | 704 x 800 x 20 mm | ES408040F | | 73.00 € |
| | 704 x 1000 x 20 mm | ES401040F | | 94.00 € |
| | 704 x 1200 x 20 mm | ES401240F | | 107.00 € |



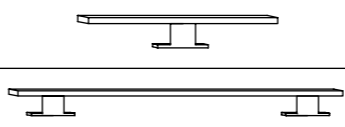

ÉCLAIRAGE LED

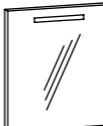
| | H*L*P | Code | Finitions | PPHT |
|---|-------------------|-----------|-----------|---------|
|  | 50 x 300 x 100 mm | IL103010F | CHROME | 45.00 € |
| | 50 x 600 x 100 mm | IL106010F | | 86.00 € |









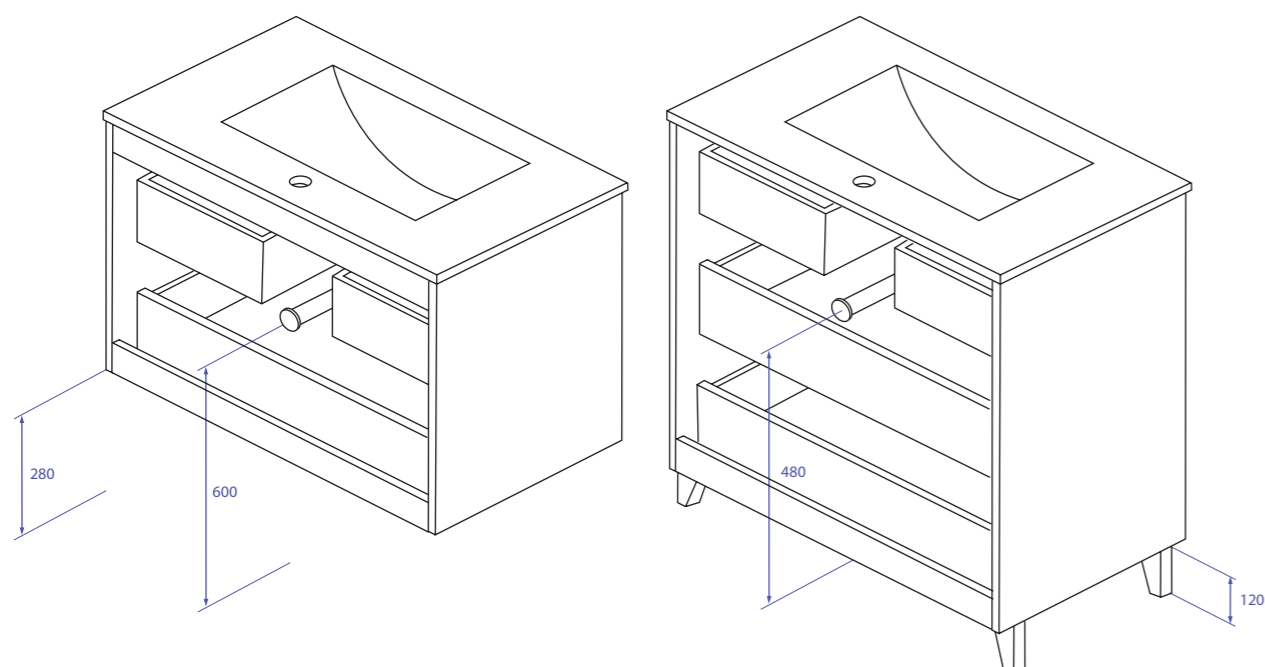

MIROIR LED LINEAL

| | H*L*P | Code | Finitions | PPHT |
|---|--------------------|-----------|-----------|----------|
|  | 704 x 600 x 30 mm | ES416040F | ALUMINIUM | 128.00 € |
| | 704 x 800 x 30 mm | ES418040F | | 162.00 € |
| | 704 x 1000 x 30 mm | ES411040F | | 195.00 € |
| | 704 x 1200 x 30 mm | ES411240F | | 214.00 € |



| | |
|-------------------------|--|
| STRUCTURE | Panneaux de 18mm |
| FAÇADE | Panneaux de 18mm mélamine imitation bois ou ciment |
| LATERAUX | Panneaux de 18mm mélamine imitation bois ou ciment |
| POIGNEES / PIEDS | Métalliques poignées avec finition noir mat. ABS pieds avec finition noir mat |
| TIROIRS | Tiroirs en structure métallique avec glissières occultes, ouverture partielle et fermeture avec amortisseur incorporé |
| CHARNIERES | Ouverture 105°, tête charnière 35mm, montage rapide, fermeture avec amortisseur hydraulique incorporé |
| FIXATION MURALE | Fixations invisibles, montage directe de grande résistance à la charge, réglage en Prof. et hauteur |
| TABLETTES | Tablettes de 18 mm en mélaminé assorties au fini extérieur |
| FINITIONS |  FRESNE GLACIAL  CIMENT  CHÈNE CLAIR  PINE JACKSON |



- | | | | |
|---|--|---|--|
|  Standard EN 120 |  Lumière LED |  Plan Vasque Céramique |  Système Soft Close Tiroirs |
|  Conformité Européenne |  IP 44 - Class II |  Mélamine |  Système Soft Close Portes |
|  Garantie de 2 ans |  Miroir avec lumière intégrée | | |

INFINITY

INFINITY ciment
Set 100cm: **976.00€**
Porte-serviette d'escalier: 212.00€





INFINITY pine Jackson
Set 100cm: **890.00€**
Porte-serviette d'escalier: 212.00€

INFINITY fresne glaciale
Set 80cm: **871.00€**
Tabouret: 254.00€
Armoire: 233.00€



INFINITY chêne clair
Set 100cm: **890.00€**
Porte-serviette d'escalier: 212.00€

MEUBLE LAVABO AVEC 2 TIROIRS ET STRUCTURE METALLIQUE

| | H*L*P | Code | Finitions | PPHT |
|--|---------------------|-----------|----------------|----------|
| | 820 x 700 x 479 mm | MB506030F | FRESNE GLACIAL | 552.00 € |
| | | MB506031F | CHÊNE CLAIR | 552.00 € |
| | | MB506032F | CIMENT | 552.00 € |
| | | MB506035F | PINE JACKSON | 552.00 € |
| | 820 x 900 x 479 mm | MB508030F | FRESNE GLACIAL | 597.00 € |
| | | MB508031F | CHÊNE CLAIR | 597.00 € |
| | | MB508032F | CIMENT | 597.00 € |
| | | MB508035F | PINE JACKSON | 597.00 € |
| | 820 x 1100 x 479 mm | MB501030F | FRESNE GLACIAL | 640.00 € |
| | | MB501031F | CHÊNE CLAIR | 640.00 € |
| | | MB501032F | CIMENT | 640.00 € |
| | | MB501035F | PINE JACKSON | 640.00 € |

ARMOIRE AVEC 1 PORTE RÉVERSIBLE ET STRUCTURE METALLIQUE

| | H*L*P | Code | Finitions | PPHT |
|--|--------------------|----------|----------------|----------|
| | 950 x 300 x 180 mm | A503030F | FRESNE GLACIAL | 233.00 € |
| | | A503031F | CHÊNE CLAIR | 233.00 € |
| | | A503032F | CIMENT | 233.00 € |
| | | A503035F | PINE JACKSON | 233.00 € |

TABOURET AUXILIAIRE

| | H*L*P | Code | Finitions | PPHT |
|--|--------------------|----------|----------------|----------|
| | 450 x 350 x 350 mm | S503530F | FRESNE GLACIAL | 254.00 € |
| | | S503531F | CHÊNE CLAIR | 254.00 € |
| | | S503532F | CIMENT | 254.00 € |
| | | S503535F | PINE JACKSON | 254.00 € |

PORTE-SERVIETTE D'ESCALIER

| | H*L*P | Code | Finitions | PPHT |
|--|--------------------|-----------|-----------|----------|
| | 1500 x 350 x 20 mm | TO504525F | NOIR MAT | 212.00 € |

LAVABO CÉRAMIQUE RADO

| | H*L*P | Code | Finitions | PPHT |
|--|-----------------|-----------|----------------|----------|
| | 19 x 610 x 460 | LA106018F | BLANC BRILLANT | 87.00 € |
| | 19 x 810 x 460 | LA108018F | | 112.00 € |
| | 19 x 1010 x 460 | LA101018F | | 156.00 € |

MIROIR LISSE

| | H*L*P | Code | Finitions | PPHT |
|--|--------------------|-----------|-----------|---------|
| | 704 x 600 x 20 mm | ES406040F | ALUMINIUM | 58.00 € |
| | 704 x 800 x 20 mm | ES408040F | | 73.00 € |
| | 704 x 1000 x 20 mm | ES401040F | | 94.00 € |





ÉCLAIRAGE LED

| | H*L*P | Code | Finitions | PPHT |
|--|-------------------|-----------|-----------|---------|
| | 50 x 300 x 100 mm | IL103010F | CHROME | 45.00 € |
| | 50 x 600 x 100 mm | IL106010F | | 86.00 € |

MIROIR LED LINEAL

| | H*L*P | Code | Finitions | PPHT |
|--|--------------------|-----------|-----------|----------|
| | 704 x 600 x 30 mm | ES416040F | ALUMINIUM | 128.00 € |
| | 704 x 800 x 30 mm | ES418040F | | 162.00 € |
| | 704 x 1000 x 30 mm | ES411040F | | 195.00 € |



| | |
|---------------------------|--|
| STRUCTURE | Panneaux de 18mm |
| FAÇADE / LATÉRAUX | Panneaux de 18mm mélamine imitation bois ou ciment |
| PORTE-SERVIETTE/ PIEDS | Structure métallique en finition noir mat |
| POIGNEES | Profil type Gola avec finition noir mat |
| TIROIRS | Tiroirs en structure métallique avec glissières occultes, ouverture partielle et fermeture avec amortisseur incorporé |
| CHARNIERES | Ouverture 105°, tête charnière 35mm, montage rapide, fermeture avec amortisseur hydraulique incorporé |
| FIXATION MURALE | Fixations invisibles, montage directe de grande résistance à la charge, réglage en Prof. et hauteur |
| TABLETTES | Tablettes de 18 mm en mélaminé assorties au fini extérieur |
| FINITIONS |  FRESNE GLACIAL  CIMENT  CHÈNE CLAIR  PINE JACKSON |

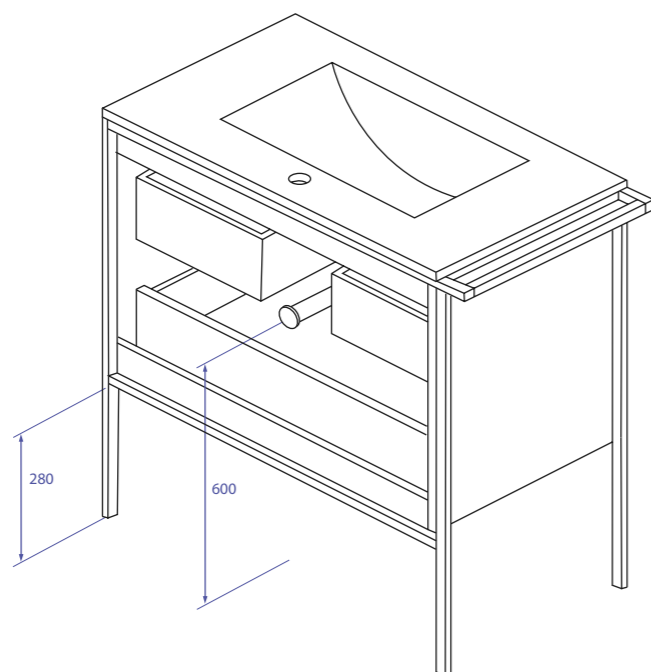

E-1 Standard EN 120

CE Conformité Européenne

VIDE SANITAIRE Garantie de 2 ans

LED Lumière LED

IP44 CLASS II IP 44 - Class II

Miroir avec lumière intégrée

Plan Vasque Céramique

Mélamine

SOFT CLOSE Système Soft Close Tiroirs

SOFT CLOSE Système Soft Close Portes

PETIT

PETIT 2 Tiroirs
Set finition bois: **000.00€**
Set laqué haute brillance: **000.00€**

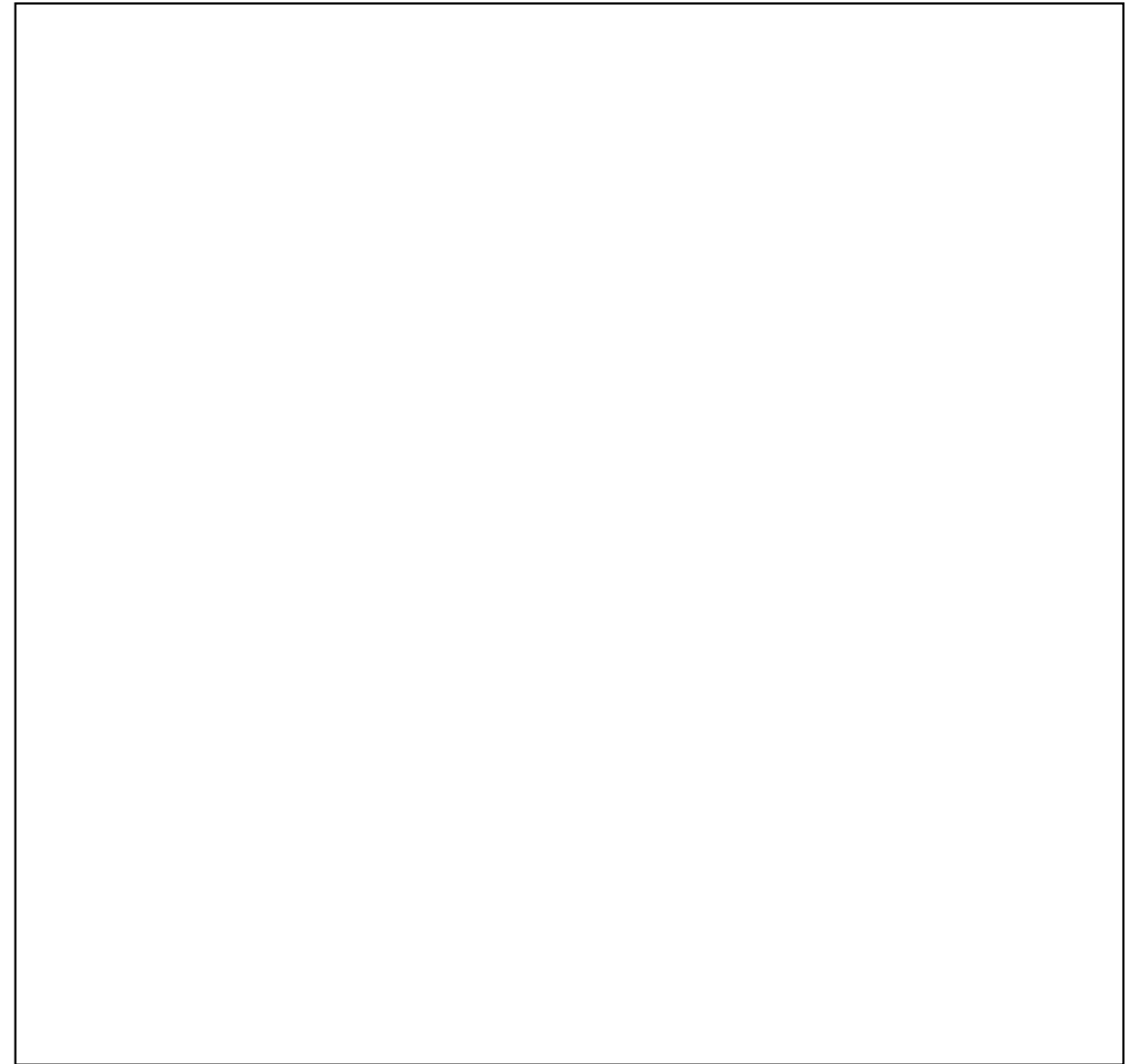

PETIT 2 Portes
Set finition bois: **000.00€**
Set laqué haute brillance: **000.00€**

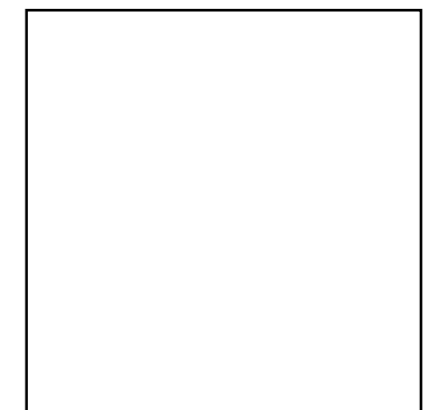
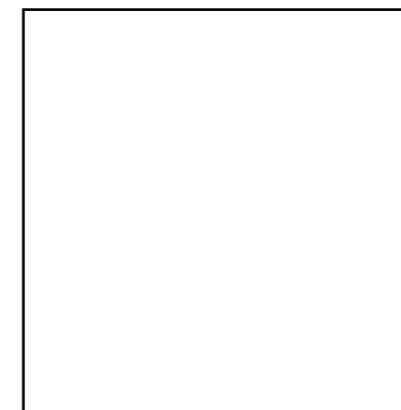
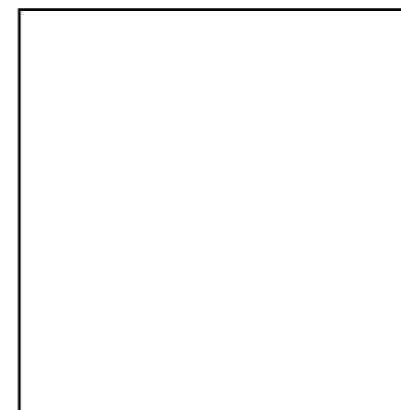
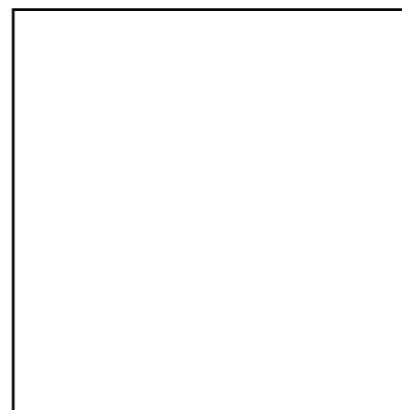
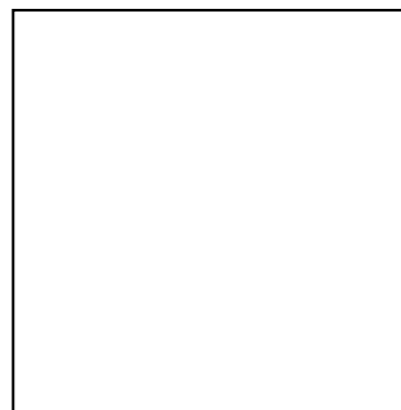

MEUBLE LAVABO AVEC 2 TIROIRS

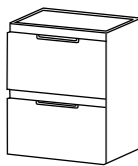
| H*L*P | Code | Finitions | PPHT |
|---|-------------|---------------------|----------|
|  600 x 480 x 360 mm | MB2C546012F | FRESNE THÉ | 262.00 € |
| | MB2C546013F | FRESNE GRIS | 262.00 € |
| | MB2C546031F | CHÊNE CLAIR | 262.00 € |
| | MB2C546018F | BLANC BRILLANT | 319.00 € |
| | MB2C546020F | ANTHRACITE BRILLANT | 319.00 € |

MEUBLE LAVABO AVEC 2 PORTES

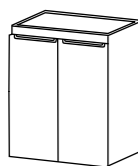
| H*L*P | Code | Finitions | PPHT |
|---|-------------|---------------------|----------|
|  600 x 480 x 360 mm | MB2P546012F | FRESNE THÉ | 220.00 € |
| | MB2P546013F | FRESNE GRIS | 220.00 € |
| | MB2P546031F | CHÊNE CLAIR | 220.00 € |
| | MB2P546018F | BLANC BRILLANT | 276.00 € |
| | MB2P546020F | ANTHRACITE BRILLANT | 276.00 € |

LAVABO CÉRAMIQUE PETIT

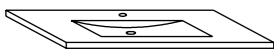
| H*L*P | Code | Finitions | PPHT |
|--|----------|----------------|----------|
|  18 x 480 x 360 | LA544818 | BLANC BRILLANT | 000.00 € |

MIROIR LISSE

| H*L*P | Code | Finitions | PPHT |
|--|-----------|-----------|---------|
|  704 x 500 x 20 mm | ES405040F | ALUMINIUM | 52.00 € |

ÉCLAIRAGE LED

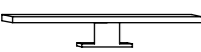
| H*L*P | Code | Finitions | PPHT |
|--|-----------|-----------|---------|
|  50 x 300 x 100 mm | IL103010F | CHROME | 45.00 € |

MIROIR LED LINEAL

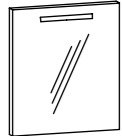
| H*L*P | Code | Finitions | PPHT |
|--|-----------|-----------|----------|
|  704 x 500 x 30 mm | ES415040F | ALUMINIUM | 114.00 € |

FINITIONS



| | |
|------------------------|---|
| STRUCTURE | Panneaux de 18mm |
| FAÇADE | Panneaux de 18mm: Structurés en mélaminé et finition brillant couleurs en MDF laqué |
| LATERAUX | Panneaux de 18mm: Structurés en mélaminé et finition brillant couleurs en MDF laqué |
| POIGNEES | Métallique poignées avec finition noir mat |
| TIROIRS | Avec guide en polilaminé gris et fermeture avec amortisseur incorporé |
| CHARNIERES | Ouverture 105°, tête charnière 35mm, montage rapide, fermeture avec amortisseur hydraulique incorporé |
| FIXATION MURALE | Fixations invisibles, montage directe de grande résistance à la charge, réglage en Prof. et hauteur |
| TABLETTES | Tablettes de 18 mm en mélaminé assorties au fini extérieur |
| FINITIONS | |

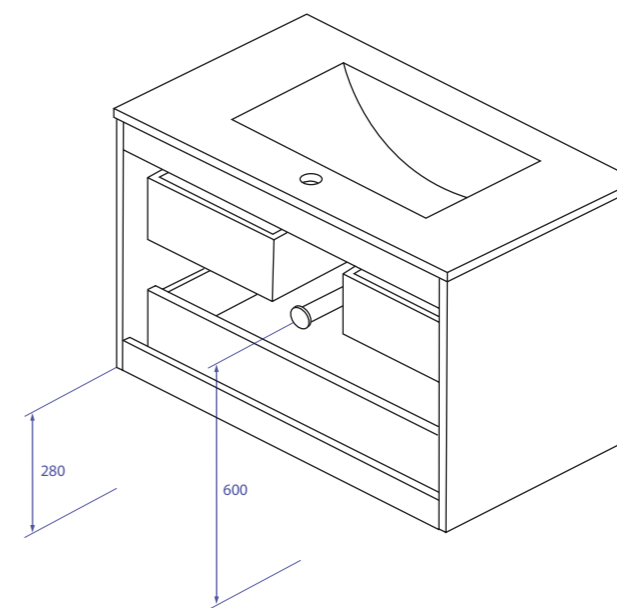

- Standard EN 120
- Lumière LED
- Plan Vasque Céramique
- Système Soft Close Tiroirs
- Conformité Européenne
- IP 44 - Class II
- Mélamine
- Système Soft Close Portes
- Garantie de 2 ans
- Miroir avec lumière intégrée
- Laqué Haute Brillance



FRESNE THÉ



FRESNE GRIS

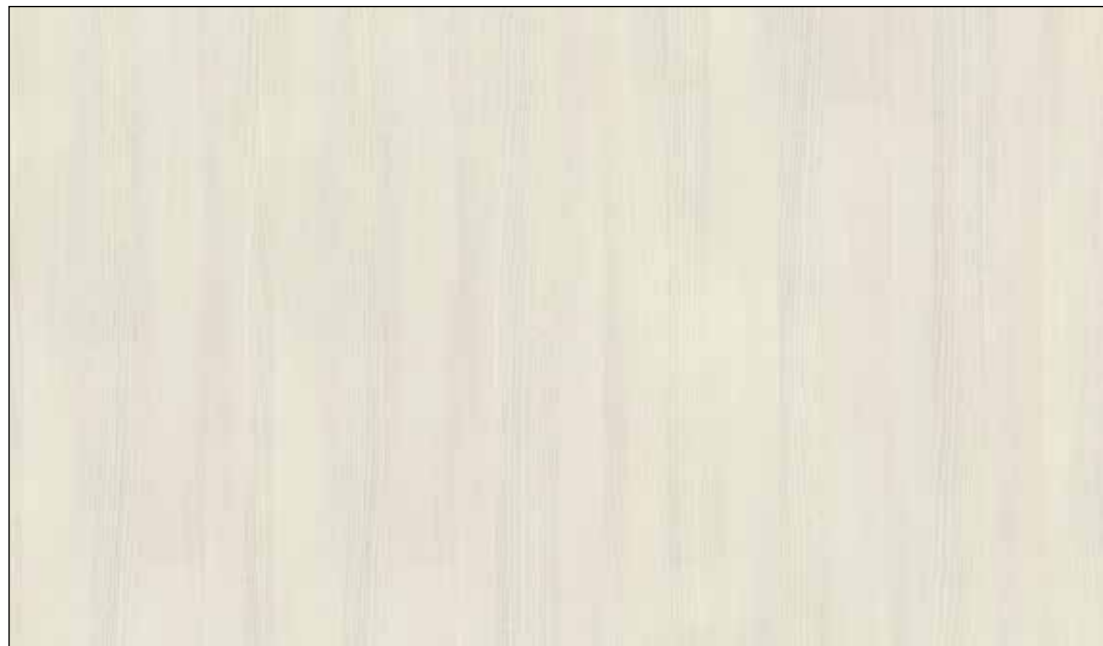

FRESNE GLACIAL



CHÊNE CLAIR



CIMENT



PINE JACKSON



CHÊNE AREZZO

BLANC BRILLANT

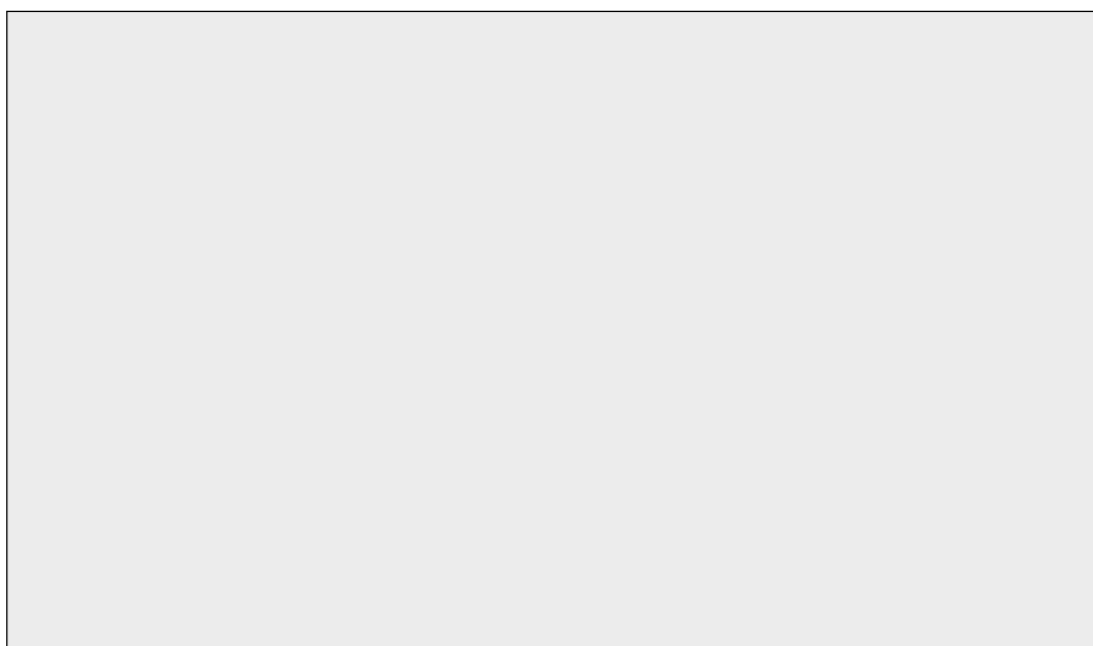

ANTHRACITE BRILLANT

**GENERAL**

La réception d'une commande par e-mail ou par fax implique l'acceptation par l'acheteur de nos conditions générales de vente. Armobany, S.L. se réserve le droit de modifier ses prix à tout moment, car nos tarifs ne sont qu'indicatifs. Aucun paiement ne sera effectué pour les différences de prix car tous nos bons de livraison sont valorisés. Armobany, S.L. se réserve le droit d'annuler ou de réduire toute proposition de commande. Armobany, S.L. se réserve le droit de retirer ou d'incorporer des produits de catalogues lorsqu'il le juge approprié et sans préavis. Prix de vente au public, TVA non comprise. Armobany, S.L. décline toute responsabilité pour les erreurs d'impression ou les omissions pouvant figurer dans ce catalogue. Les couleurs du catalogue sont approximatives et ne peuvent être réclamées. Les différences de tonalité ne seront pas considérées comme des défauts.

LIVRAISON DU PRODUIT

Les produits seront livrés à nos clients aux frais de port payés à condition que les commandes soient supérieures à 600 € net, en cas d'atteinte de ce montant, vous devrez payer le coût de l'agence de transport. Le délai de livraison maximum sera de 10 jours tant qu'il y aura de la disponibilité et que la société aura établi un itinéraire de livraison dans la zone du client. Le client a l'obligation de vérifier et de contrôler complètement le produit lors de la livraison, en nous informant par écrit de toute anomalie, défaut ou rupture constatée par courrier électronique ou par fax, dans un délai maximum de 24 heures, sauf vice caché.

RETOUR DE MATERIEL

Armobany, S.L. traitera les retours du matériel présentant un défaut de fabrication à condition qu'ils soient couverts par la garantie du fabricant. De même, il ne sera pas responsable des pertes éventuelles causées par un matériel défectueux. Armobany, S.L., en règle générale, n'acceptera pas les retours de matériel lorsque deux jours ouvrables se sont écoulés depuis la date de livraison. Aucun retour de matériel spécial sur demande ne sera accepté. En cas d'acceptation d'un remboursement en dehors de la durée estimée, Armobany, S.L. se réserve le droit d'appliquer une dépréciation de 30% du prix facturé. En aucun cas, les retours de matériel cassé, en mauvais état ou de matériel interrompu au moment de l'achat ne seront acceptés, quel que soit leur statut.

DÉLAI DE LIVRAISON

Armobany, S.L., s'engage à fournir les commandes dans les meilleurs délais. En aucun cas, le retard de livraison d'une commande, ou d'une partie de celle-ci, n'entraînera de compensation ou d'acceptation de retard dans le paiement de la marchandise servie.

GARANTIE

Les marchandises sont garanties conformément à la réglementation européenne en vigueur. Cette garantie comprend 24 mois à compter de la date d'expédition du produit et les réclamations indiquées par écrit sont considérées comme valides. La garantie ne couvre pas les dommages non imputables au produit ou résultant d'une négligence dans sa manipulation. La société assume la garantie de ses produits, étant entendu et expressément convenu que cette garantie sera limitée au remplacement des produits défectueux, à l'exclusion de tout autre dommage ou de toute indemnité d'intérêt.

PAIEMENT ET BONUS

El incumplimiento por parte del comprador de las condiciones de pago previamente acordadas dará derecho a Armobany, S.L. a retener o anular los pedidos que se encuentren pendientes de suministrar a dicho comprador.

CONDITIONS DE PAIEMENT

Les achats effectués jusqu'à la concession de classification du risque seront réglés en espèces lors de la décharge, une fois la cote de crédit attribuée, les montants facturés seront envoyés dans un délai de 3 jours maximum au compte bancaire indiqué par le client. Les commandes inférieures à 100 euros seront réglées en espèces.

JURIDICTION

a bonne foi et les relations avec nos clients nous amènent à ne pas penser à d'éventuelles actions en justice, mais si nécessaire, les deux parties se soumettront devant les tribunaux et les tribunaux de Valencia.

ARMOBANY, S.L.

ARMOBANY, S.L.

P. I. Picassent, Calle 5, Nave 8, Buzón 65
46220 PICASSENT (Valencia) Spain

T: + 34 961 216 476

F: + 34 961 216 477

armobany@armobany.eu

www.armobany.eu

DIRECTION France: AGIRS

ZA, 8 rue de la Forge

35830 BETTON France

Tel: +33 02 99 55 93 17

commercial.stephanie@cvsm.fr

www.agirs.fr